

Gifts

PROMOTIONAL
PRODUCT
COLLECTIONS





POWER OF PROMOTIONAL GIFTS

Promotional Items allow people to see your brand, associate with your brand and recognize it. Promotional Gifts will stay with your clients and your logo will be seen time after time.

WHY CHOOSE US?

- Largest supplier of Promotional Gifts in Middle East since 1989.
- Established company with excellent track record for Best Customer Service.
 - Large collection of products to choose from.
 - Items Ready in Stock with Large Quantities available.
 - Different Branding options to choose from.
- All branding is done in-house with fast delivery.
 - Large production facility
 - Competitive Prices.



JANNAH LEGASPI
BUSINESS DEVELOPER MANAGER

 Al Sheik Muhamad
Bin Sayed Shop #1,
Industrial 11, Sharjah U.A.E.
 +971 50 229 6087
 info@highprofile-advertising.com
 www.highprofile-advertising.com

WHAT WE OFFER!

- ▶ Promotional Gifts
- ▶ Technology Gifts
- ▶ Caps, T-Shirts & Polo Shirts
- ▶ Promotional Shopping Bags
- ▶ Stationeries
- ▶ Medals, Pins & Badges
- ▶ Lanyards, Reel Badges & ID Holders
- ▶ Promotional Watches & Clocks
- ▶ Acrylic Awards & Wooden Plaques
- ▶ Crystal Awards
- ▶ UAE National Day Products
- ▶ Sublimation Blanks
- ▶ Sublimation Papers & Inks
- ▶ Heat Transfer Vinyls & Flocks
- ▶ Heat Press Machineries
- ▶ Laser Marking Machines
- ▶ Cutting Plotters
- ▶ Button Badge Machines
- ▶ Button Badges & Components
- ▶ Epoxy Chemicals & Accessories

READY STOCK

Choose from our products & brand it right away!

5000+ different promotional gifts to choose from. With Large Printing & Production facility, We make sure we provide you the best branding for your desired gift.

CATALOGUE INFORMATION

Colours of the actual products may slightly differ from the printed colours shown. Some product sizes have indicated in cm / mm. Size may vary slightly from those indicated. We make sure product details are provided, however due to volume of information some data / info you need or looking for might have not been included.

Please request a sample for accurate color, size, design & information.

Catalogue Guide

Basic Product Information

JU-WPB-10000 Refers to the item number

Wireless Powerbank Product Name

Capacity : 10,000mAh
Size : 142 x 70 x 16 mm Basic description or specification of the product.

Printing Options :
• Full Color UV Printing
• Screen Printing Available Printing options of the chosen Product.

Colour Abbreviations

 W White	 Y Yellow	 LP Light Pink	 LGR Light Green
 BK Black	 OR Orange	 PK Pink	 SBL Sky Blue
 SL Silver	 R Red	 DP Dark Pink	 BL Blue
 G Gold	 M Maroon	 GR Green	 DBL Dark Blue

In some items, you might see such colour boxes. it means product is available in such colours.
* This colour code does not apply on all products *

Know your Logo!

Each Product can be mark with different printing options, Each printing option have its capabilities and limits – Size, number of used colours, etc.

LOGO

Monochromatic or Single Color Logo

Laser Marking, Laser Engraving
Debossing, 1 color Screen Printing

LOGO

Colour Logo (separate)

UV Printing, Screen Printing,
Digital Printing

LOGO

Gradient Logo

UV Printing, Digital Printing,
Sublimation, Heat Transfer.

BRANDING



SCREEN PRINTING

The process whereby a logo is exposed into a mesh screen. Ink is then placed onto the screen and squeegee pushes the ink through the screen in the areas where the logo has been imposed.



DIGITAL PRINTING

A method of printing from a digital-based image directly to a variety of media. It usually refers to professional printing where small run jobs from desktop publishing and other digital sources are printed using small / large-format and / or high-volume laser or inkjet printers.



PAD PRINTING

A Printing process that transfer 2D image onto a 3D object. The unique properties of the silicone pad enable it to pick the image up from a flat plane and transfer it to a variety of surfaces, such as cylindrical, spherical, compound angles, textures, concave, or convex surfaces.



UV PRINTING

UV Printing is a form of digital printing that uses Ultra-violet lights to dry or cure the ink as it is printed. The printing method is best for branding that involves gradation effect and articles that need edge to edge printing.



HEAT TRANSFER PRINTING

A digital image is printed onto a special vinyl surface, which is then placed into the product. The product is then placed in a heat press machine, where heat will merge the vinyl and the product.



3D ENGRAVING

3D Laser engraving, which is a subset of laser marking, is the practice of using lasers to engrave letters, logo or even images inside the crystal which will be scaled to size and reproduced with exactly defined strokes.

Almost every product in this catalogue can be branded, Selecting the correct branding method is needed to ensure maximum exposure of your logo.



SUBLIMATION PRINTING

A process done by way of full-colour printer which is fitted with special sublimation inks. The logo is printed onto a special transfer paper, then placed into the product where heat is applied causing the inks to migrate from paper to product.



EPOXY DOMING

Doming is used to create a version of your logo by shaping a raised surface beneath the print. A mould is formed, printed and filled with epoxy which then is hardened to maintain its shape.



DEBOSSING

Debossing is the opposite of embossing as you are creating an indent in the material you are using. A metal die is stamped onto the front of the material you are using causing depressions that leave a imprint of the image on your products.



FOILING

Foil printing is a speciality printing process which uses heat, pressure and metallic paper (foil). This is used to create different shiny designs and graphics on various materials.



METAL MARKINGS

A logo is etched into a product with a laser beam, replicating the logo with precise accuracy. The laser "burns" the top layer of the product off and reveals the layer beneath.



LASER CUTTING & ENGRAVING

A sheet of Acrylic have been used to replace less durable materials like glass in many different ways. Laser can cut through some pretty powerful stuff, even materials as hard as aluminium sheets, plastics and acrylic sheets.

TABLE OF CONTENT

Technology Gifts

10

Powerbanks, Portfolios, Car Chargers, Speakers & Headphones
Travel Adaptors, Multi-charging Cables, USB Flash Drives.

Writing Instruments

56

Maxema - Italian Pens, Raphael Pens, Amabel Designs, Dorniel Designs,
Parker Pens, Promotional Metal & Plastic Pens, ECO Friendly Pens.

General Gifts

118

Notebooks & Notepads, Keychains, Tools, Business Card Holder & Wallets,
Clocks, Mobile Accessories, Tyvek & Silicone Products & more.

- ▶ Travel Essentials
- ▶ Fitness Products
- ▶ Personal Products
- ▶ Health Care Products
- ▶ Drinkwares
- ▶ Large selection of bags
- ▶ Wearables
- ▶ Button Badges
- ▶ Children's Gift
- ▶ ECO Friendly Products
- ▶ Promotional Gift Sets

Awards & Plaques

212

Crystal Awards, Acrylic Awards & Wooden Plaques

Pins & Badges

220

Large Selection of Ready Made & Custom-made Metal Badges, Medals,
Name Badges, Accessories

ID Solutions

244

15mm & 20mm Lanyards, Double Hook Lanyards, Sublimation Lanyards,
Plastic & Metal Reel Badges, ID Card Holders.

Sublimation Solutions

254

Ceramic Mugs, Steel Mugs & Bottles, Tea Coasters, Ceramic Products,
Photo Rocks, Photo Crystals, Puzzles, Carpets, Wall/Desk Sign Holder.

Customized Products

289



TECHNOLOGY PRODUCTS

As the technology advances, So do our gifts.
We offer a wide range of technology products such as
Powerbanks, Car chargers, Speakers, Travel adaptors,
Multi-charging cables & USB Flash drives.



World of Wireless Technology

Charging made Easier



Wireless charging is the process of electrically charging battery-powered devices and equipments without the need for a wired electrical power connection. It enables the wireless transfer of electrical charge from a charging device or node to the recipient device.

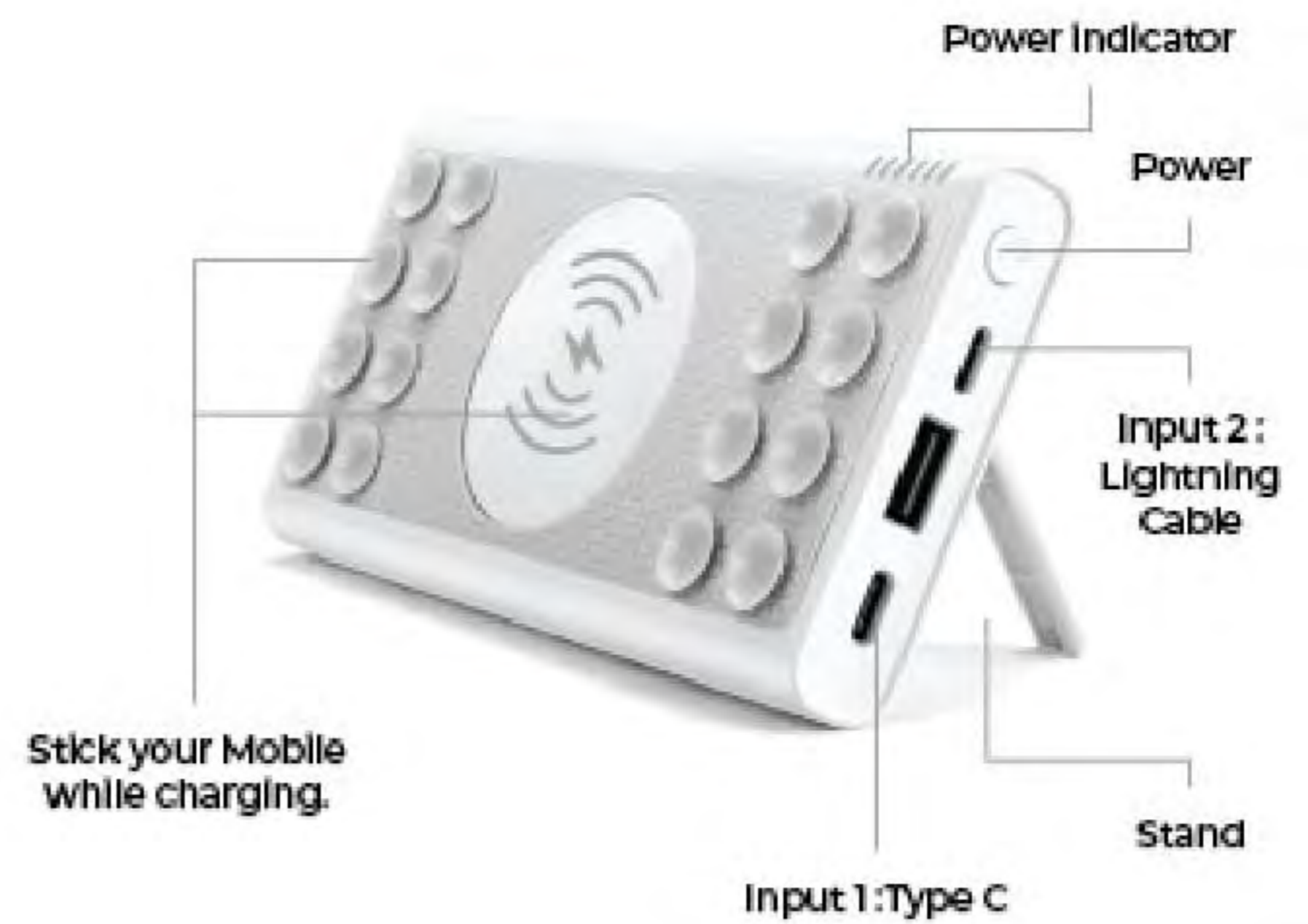

JU-WPB-10000

10,000 mAh Wireless Powerbank with Suction Cup

This powerbank applies for all Qi standard receiver Powerbank with a capacity of 10,000 mAh, product dimension is 142 x 70 x 16mm with a packing box of 170 x 110 x 45mm, Input : DC 5V/2A, Output : DC 5V/2.4A, Wireless Output : 5W Wireless charging distance of <8mm, Efficiency >74%.

- Printing Options :
- Full Color UV Printing
 - Screen Printing





JU-WPB-8000

8,000 mAh Light Up Wireless Powerbank with Suction Cup

Black rubber finish with a suction cup for your mobile, Lithium Polymer Battery, Product Size : 140 x 71 x 17 mm.
 2 Input (micro & type c): DC 5V/2.1A
 2 USB Output : DC 5V/2.1A Wireless Output : 5W

Printing Options :
 • Laser Engraving (Light up Logo)



JU-WPB-4000

4,000 mAh Wireless Powerbank Wallet

A smart way to carry your valuables, Leather cover wallet with magnetic clasp, 3 ID card pockets & 1 transparent ID pocket.
 Capacity : 4000mAh, Product Size : 170 x 110 x 15mm.
 Input : DC 5V/1A, Output : DC 5V/1.4A, Wireless Output : 5W

Printing Options : Laser Markings





Wireless charger for smartphones under the Qi-Standard. Easy to charge your phone without cables. Just put your phone on the top of the charging pad.



JU-WCP-1
Wireless Charger

Input : DC 5V / 2.1 A
Wireless Output : DC 5V / 1.0 A
Compatible with Qi-Standards
Dimensions : 90 x 90 x 8 mm

- Printing Options :
- Full Color UV Printing
 - Screen Printing



JU-WCP-02
Wireless Charger Stand

Input : DC 5V / 1.5 A, Wireless Output : DC 5V / 1.0 A / 5 W
Compatible with Qi-Standards, Maximum Distance : 10 mm
Dimensions : 90 x 145 mm

- Printing Options : Full Color UV Printing



BK



W

CHARGE YOUR PHONE
“ WIRELESSLY ”



CAR-WS
Wireless Car Charger Mount

Input : DC 5V / 2A
Wireless Output : 5W
Compatible with Qi-Standards

Printing Options:
• Full color printing with epoxy
• Full Color UV Printing

Just Insert on your Car Air vents & charge your phone wirelessly.



3 in 1: Multi-charging cable included.



JU-PB-5000-W

5,000 mAh Mini Size Powerbank

Slim & Portable Design with Incredible texture. 4 dot light battery indicator, Lithium Polymer Battery Capacity : 5000mAh, Product Size : 90 x 63 x 13 mm. Input : DC 5V/2.1A, Output : DC 5V/2.1A

Printing Options: Full Color UV Printing



JU-PB-15000D

15,000 mAh Powerbank

Powerbank with White Textured Design, Large Battery capacity and a digital screen display. 3 Slots USB port, 4 LED bulb flash light, packed in zipper pouch
Capacity : 15000mAh, Product Size : 150 x 64 x 23 mm.
Input : DC 5V/2.1Ah, Output : DC 5V/2.1A

Printing Options : Full Color UV Printing, Screen Printing

“ Make it Portable ”
STICK it, then
CHARGE it!



JU-PB-4000-S-SL

4,000 mAh Powerbank with Suction Cup and Charging cable

Ultra Slim Portable Powerbank with Suction cup on the back. Polymer Battery, Easy On/Off Button & Power level indicator
Capacity : 4000mAh, Product Size : 96 x 62 x 7 mm.
Input : DC 5V/1Ah, Output : DC 5V/1A

Printing Options :
• Full Color UV Printing
• Screen Printing





Select your own Leather Covers
Great choice for Debossing or Full Color Printing.



JU-PB-6000

6,000 mAh Leather Powerbank

Leather cover can be changed to your desired texture and colors.
Slim & Portable design with Stainless gold plated metal body.
Capacity : 6,000mAh , Product Size : 127 x 70 x 11 mm
Input : DC 5V/1Ah, Output : DC 5V,1A/2Av

Printing Options : Debossing or Full Color UV Printing



JU-PB-6500

6,500 mAh Powerbank

A Powerbank with Great texture design, Digital screen display,
2 slot USB port and LED Flash Light.
Capacity : 6500mAh, Product Size : 95 x 63 x 28mm.
Input : DC 5V/2.1A, Output : DC 5V/2.1A

Printing Options : Full Color UV Printing, Screen Printing





JU-PB-8000

8,000 mAh Powerbank

Powerbank with White Luxury Design & Digital screen Display.
 3 Slots USB port, 2 LED bulb flash light,
 Capacity : 8000mAh, Product Size : 120 x 73 x 15 mm.
 Input : DC 5V/2.1Ah, Output : DC 5V/2.1A

Printing Options : Full Color UV Printing, Screen Printing



JU-PB-2200

2,200 mAh Powerbank

Small and Portable design
 Packed in a zipper pouch
 Product Size : 90 x 30 x 21 mm.
 Input : DC 5V/800mAh, Output : DC 5V/1A

Printing Options : Full Color UV Printing, Screen Printing



Crystal Area
for Laser Engraving



JU-PB-4000-CR

4,000 mAh Rubberized Powerbank with Crystal

Rubberized texture and crystal for engraving, LED light up for Logo.
Capacity : 4000mAh, Product Size : 122 x 70 x 13 mm.
Input : DC 5V/1Ah, Output : DC 5V/1A

Printing Options : • Laser Engraving (Inside the crystal)



Color Changing Powerbank

Engraved design changes colour as the battery depletes.



Battery Level :
100 - 60%
Green Light



Battery Level :
59 - 30%
Blue Light



Battery Level :
29 - 0%
Red Light



JU-PB-5000

5,000 mAh Light Up Powerbank

Slim Powerbank that lights up logo while charging.
Lithium Polymer Battery, Easy On/Off Button & Power level indicator
Capacity : 5000mAh, Product Size : 126 x 66 x 12 mm
Input : DC 5V/1Ah, Output : DC 5V/1A

Printing Options : Laser Engraving

Tech-Smart Features

POWERBANK PORTFOLIOS



JU-FL-8000

Wireless Power bank Portfolio with Light Up Logo

High quality black leather cover Powerbank Portfolio comes with wireless charging & light up logo. Inside has 4 strips of ID card pockets, paper pockets, A5 sized notebook & pen holder. Powerbank capacity is 8000 mAh. USB Flash drive capacity is 32 GB. Product Size : 185 x 240 x 40 mm

Printing Options :

- Laser Engraving (Light Up Logo)



iOS & Android cable attachment



Packed in a Black Luxury Cardboard Box



DORNIEL DESIGNS

MB-07-8000

Power bank Portfolio

High quality cloth & PU covered Power Bank Portfolio comes with phone holder, card holder, pockets elastic webbings for cables & accessories, Pen holder & memo pad. Powerbank capacity is 8000 mAh, Product Size : 230 x 300 x 20 mm.

Printing Options :

- Full Color UV Printing
- Screen Printing
- Laser Marking on Magnetic Clasp



Mobile Stand

Pen Holder

Mesh Pocket for accessories

Mobile Holder

5 slots / pocket for ID Cards

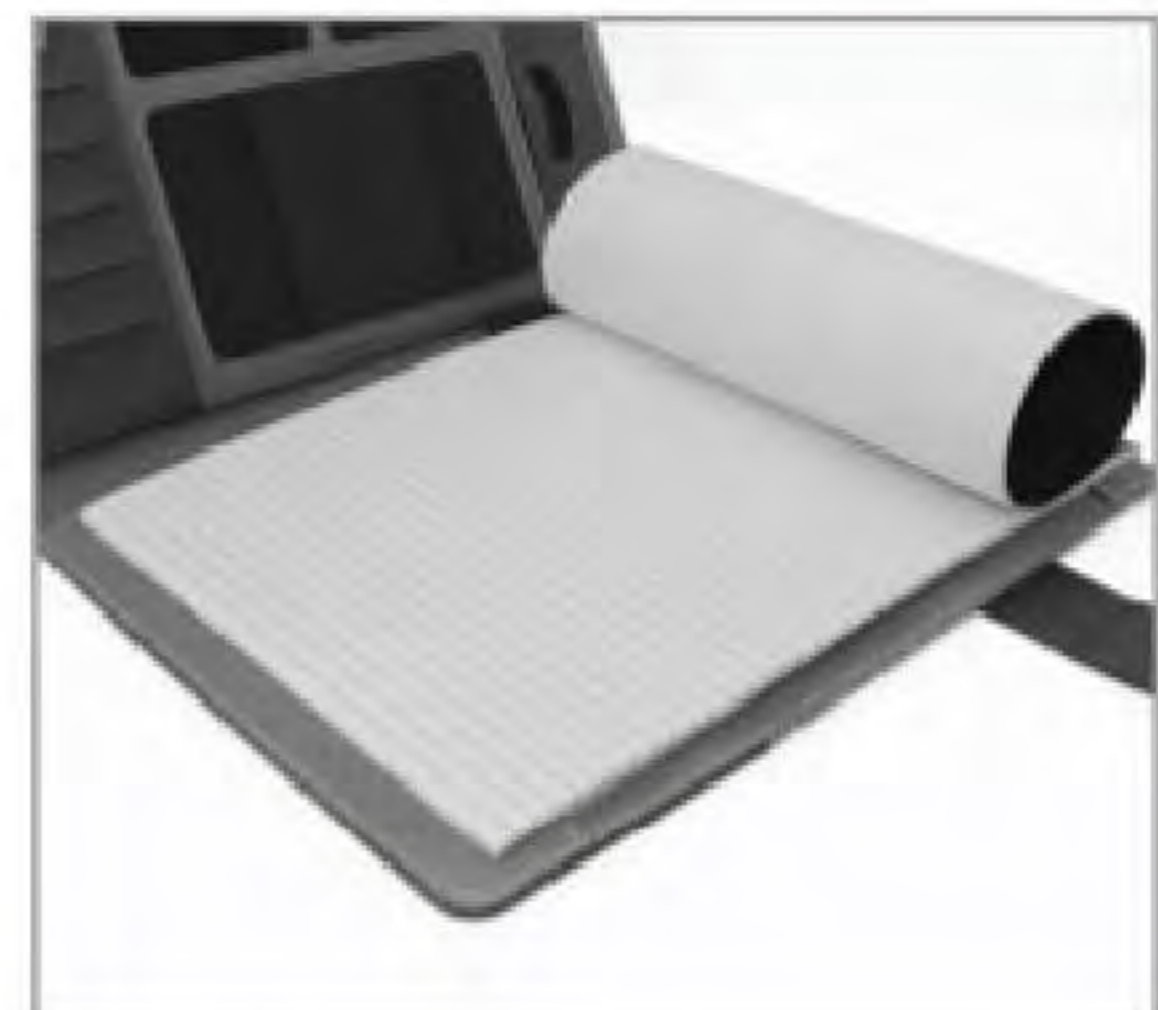



LOGO
LIGHT UP
LOGO

JU-FL-6000

Powerbank Portfolio

An Ideal gift for executives or corporate use.
Light up logo & Metal magnetic clasp area for your Logo.
Powerbank capacity : 6000 mAh with flip metal area for USB ports
Product Size : 185 x 220 x 30 mm

Printing Options : Laser Engraving (Light up Logo & Shiny Silver Effect)





Assorted Tech Products

Other Technology Gifts

Car Chargers, Travel Adaptors, Speakers & more...



BK



BL



R

CARC

USB Car Charger

Ultra Lightweight & Portable design,
30 x 30 mm LED corner light
full color printed with epoxy on center.
Product size is 70 x 30 x 30 mm.
Input : 12V - Output : 5V < 2100mA (via USB).

Printing Options :
• Full Color Printing with Epoxy



70 mm

A Great technology gift which will be usable mostly on long journeys. It allows you to charge your mobile or tablets on your car.



BK

W

CARC-S2

Swivel USB Car Charger

Small & Portable design,
Product size is 65 x 24 x 18 mm.
Input : 12V - Output : 5V < 2.100mA (via USB),
with Key Ring attachment.

Printing Options :
• Full Color UV Printing
• Screen Printing





TAKE YOUR **MUSIC**
WITH YOU WHEREVER
YOU GO!



Present your Logo / Brands
while enjoying your favorite musics.



MS-02

Bluetooth Speaker

Small & Portable Design. Soft finishing in solid white color, with Bluetooth 3.0 connection, it delivers 3W of power, has hands-free function, a slot for mini SD cards up to 32 GB and auxiliary line input via jack 3,5mm. Includes mini USB charging cable, 3,5mm auxiliary jack cable. Top side menu buttons. ABS Plastic Material
Product Size : 75 x 60 mm

Printing Options :

- Full Color UV Printing
- Screen Printing

Touch top to
change colour



MS-03

Lamp Bluetooth Speaker

7 colour interchangeable LED Light. High definition Built-In speakers which supports excellent handsfree capability. Smart and easy to use. Bluetooth wireless, Micro SD card playing & 3.5mm audio cable connection.

- Printing Options :
- Full Color UV Printing
 - Screen Printing



Your Design in
Full Color printing

Printing Area Size
86 x 50 mm

MS-04

Bluetooth Speaker with Suction cup

High fidelity speakers, supports most mobiles, Bluetooth 3.0
Loudspeaker output : 3W, Signal-to-noise : 75 dB.
Playback Time : 5 hours. Charging Time : 2 hours.
Product size : 94 x 91 x 66mm, Weight : 174 g

- Printing Options :
- Full Color UV Printing



PROMOTIONAL SPEAKERS



WIRELESS CHARGING



LIGHT UP LOGO



MS-05

Bluetooth speaker with Wireless Charging.

Light up logo bluetooth speaker
Mobile holder with wireless charging
Frequency Response: 100Hz-20KHz
Loudspeaker Output: 3W
Wireless Output: 5W
Product Size : 112 x 83 x 76 mm

Printing Options :

- Laser Engraving (Light up Logo)



LIGHT UP LOGO



MS-06

Mini cube Bluetooth Speaker

Light up logo bluetooth speaker
Small & Portable design.
Frequency Response: 100Hz-20KHz
Loudspeaker Output: 3W
Product Size : 41 x 41 x 46 mm

Printing Options :

- Laser Engraving





EAR-01

Promotional Earphone with Protective Case

Earphone presented on a white & grey plastic case, White earphone with a 3mm earphone jack . Cable lenght : 105 cm

Printing Options :
• Full Color UV Printing

EAR-PB-3600

Rubberized Wireless Earphone with Powerbank

Bluetooth earbuds, Stereo Speaker, Dual Microphone, Compatible with IOS & Android devices.
Powerbank Capacity : 3600mAh
Heaphone Capacity : 45mAh
Play time : < 4 hours
Dimensions : 65 x 120 x 25 mm

Printing Options :
• Full Color UV Printing



ENJOY
THE
MUSIC

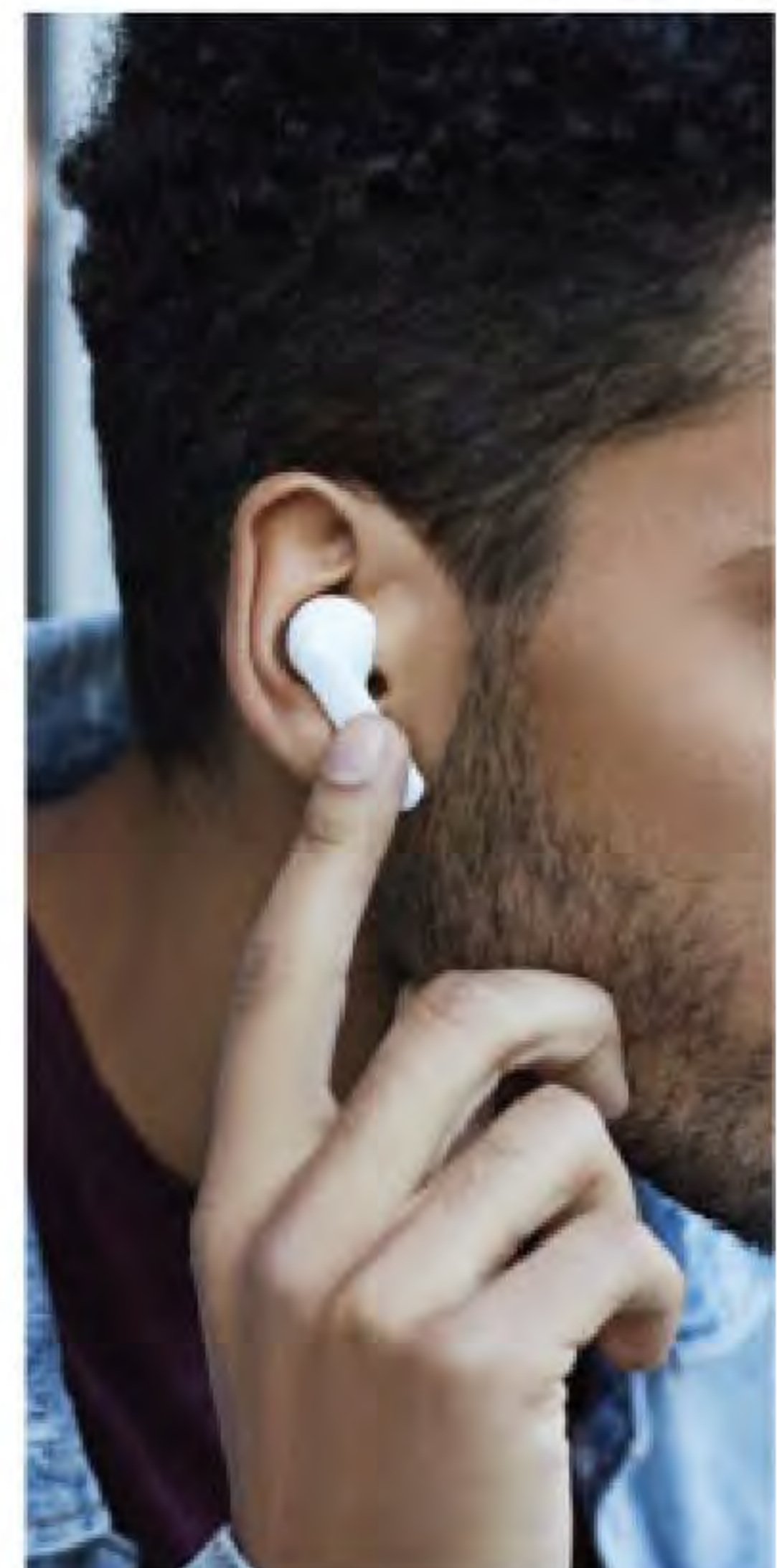



EAR-03

Promotional Wireless headphones

Bluetooth headphones. ABS. Adjustable. Round plate for logo printing on both sides. Cushioned structure, bluetooth transmission and TF card reader. Autonomy up to 4 h. Functions include modes, volume control, play / pause button. 3.5mm headphone slot. Includes USB/micro USB cable to charge.
Approx Size : 160 x 180 x 80 mm

Printing Options : Full Color UV Printing or Laser Markings



EAR-02

Promotional Wireless Earbuds with Charging case

Bluetooth headphones in black case. Incredible Sound Quality, Earbuds can shield surrounding noises, ensure sound clarity whether listening to music or talking on the phone. Comfortable Fit & Wide compatibility
Case Size : 85 x 40 x 30 mm

Printing Options : Full Color UV Printing or Screen Printing





JU-TA-001-W

Promotional Travel Adaptor

High Quality & Portable
 4 types of Plug (UK, AUS, USA, EURO)
 Input : AC 6A Max. 100-240 Vac 56/60Hz
 Output : USB 1000mA Max. +5V DC.

- Printing Options :
- Full Color UV Printing
 - Screen Printing



Packing Pouch



JU-TA-002

Promotional Travel Adaptor

High Quality & Portable
 4 types of Plug (UK, AUS, USA, EURO)
 Input : AC 6A Max. 100-240 Vac 56/60Hz
 Output : USB 1000mA Max. +5V DC.

- Printing Options :
- Full Color UV Printing
 - Screen Printing



Packing Pouch



JU-OC-L

Light Up Logo Multi-charging Cable

Small & Flexible Design.
3 in 1 charging USB cable featuring the Type C, Lightning and micro USB connectors.

Printing Options : Laser Engraving



JU-OC

Promotional Multi-charging Cable

Small & Flexible Design.
3 in 1 charging USB cable featuring the Type C, Lightning and micro USB connectors.

Printing Options :
• Full color printing with epoxy



USB-CC

Promotional Multi-charging Cable (Nylon braided)

All in 1 compact charging cable solution that you were looking for. Simple, lightweight, portable and convenient make charging easier. Its 3 in 1 charging USB cable featuring the Type C, lightning and micro USB connectors.

Printing Options :
• Laser Markings



JU-WM

Promotional Wireless Mouse

A customisable standard 2.4G wireless mouse that works within suitable range. This wireless mouse requires AAA batteries. The wireless mouse is available in black and white and is packaged in a clear transparent box with ABS casing.
 Product Size : 57 x 113 x 20 mm
 Packing Box Size: 62 x 120 x 30 mm

Printing Options :
 • Full Color UV Printing
 • Screen Printing



FAN

Portable USB Fan

Small & Flexible Design.
 Product size : 145 x 89 x 15 mm
 Rated Power : 5V -1 W

Printing Options :
 • Full Color UV Printing or Screen Printing





For Business or Personal use.

USB Flash Drives

Available in Wide range of Designs, Colors & Capacities.

USB flash drives makes an impressive & practical corporate Gifts while promoting your brand at the same time.

We are committed to be your most reliable source of USB flash drive in the Middle East.

We specialize in importing quality USB Flash Drives for promotional purposes. Our USB Flash Drives are sourced from reputable factories using quality components such as Samsung or Toshiba and carry a warranty against defects. We pride ourselves on high standard levels and after sales services to ensure you peace of mind when dealing with us.

Reasons why you choose us as your USB Flash Drive source.

- We import original chips separately and after testing & quality checking, We fix them in USB shells.
- We never import duplicate or upgrade chips and we offer warranty against defect.
- Fast delivery from ready stock.
- Big variety and range of products to select.
- Competitive prices with higher quality.
- Mock Ups and E-Samples

What are upgraded chips?

Unfortunately some manufacturers using a lower capacity memory and selling as a higher capacity memory.

What are upgraded chips?

(1) They use a software to upgrade 1 GB to 4GB. When using the chip in your computer it shows 4GB but can't accept files more than 1 GB because the real capacity is 1 GB.

(2) They use 4 pcs of 1 GB chip instead of 1 piece 4 GB memory. When you save a file more than 1 GB it will show an error and if you save a file less than 1 GB it will be saved but when you need to reopen the file, as it is not clear in which one of the chips is saved. again it will show an error.



**We never use upgrade chips
We use only original chips!**

USB-62

Metal USB Flash Drive

Material : Stainless steel (Gun metal)
 Size : 45 x 12 x 10 mm
 Capacity : 4, 8, 16 or 32 GB.

Printing Options :
 • Laser Markings



USB-64

Element USB Flash Drive

Element is simple style in stainless steel, functionality at a minimum of space and quality design object.

Material : Stainless steel (Gun metal)
 Size : 43 x 12 x 5 mm
 Capacity : 4, 8, 16 or 32 GB.

Printing Options :
 • Laser Markings



USB-65

Metal Hook USB Flash Drive

Ultra-portable and lightweight design. Easy to carry and not easy to lose for its innovative hook head can be securely attached to keychains, bags, etc.

Material : Stainless steel (Gun metal)
 Size : 48 x 15 x 4 mm
 Capacity : 4, 8, 16 or 32 GB.

Printing Options :
 • Laser Markings



USB-26

USB Flash Drive with Leather Strap

Stylish, Modern with minimalist design.
 Material : Metal & Leather
 Size : 83 x 12 x 4 mm
 Capacity : 8 GB.

Printing Options :
 • Laser Markings





USB-58

Crystal USB Flash Drive

This USB Flash drive has a crystal with high-intensity blue coloured LED light, illuminates the design for an even greater effect when connected to a computer. Which is beautiful and charming design, Suitable for luxury and memorable events.
 Material : Metal & Crystal
 Size : 60 x 20 x 10 mm
 Capacity : 8 or 16 GB.

Printing Options:
 • Laser Engraving (Inside crystal)
 • Screen Printing



USB-59

Round Crystal USB Flash Drive

Similar to USB-58 but attached is a round shape crystal with high-intensity blue coloured LED light & a polished silver cap.
 Material : Metal & Crystal
 Size : 60 x 30 mm
 Capacity : 8 or 16 GB.

Printing Options:
 • Laser Engraving (Inside crystal)
 • Screen Printing



USB-66

Metal with Crystal USB Flash Drive

Metal body with oval shaped glass for your logo. Glass area is protected with rubber.
 Material : Metal & Crystal | Size : 68 x 23 mm
 Capacity : 4, 8, 16 or 32 GB.

Printing Options: • Laser Engraving (Inside crystal)



USB-67

Square Light Up USB Flash Drive

Rubberized finish body with square shaped area for light up logo. Slide button backside to reveal chip.
 Material : Plastic | Size : 52 x 30 mm
 Capacity : 4, 8, 16 or 32 GB.

Printing Options: • Laser Engraving

USB-20

Slide USB Flash Drive

Colourful USB sticks with soft-touch case and leather straps. Simply fold the USB element in and out using the small slider.

Material : PVC (Matt Finish) & Leather

Size : 67 x 23 x 10 mm

Available Capacity : 4, 8, 16 & 32 GB.

Printing Options :

- Full Color UV Printing
- Screen Printing



USB-17

Silicone Keychain USB Flash Drive

Material : Metal & Silicone

Size : 58 x 29 x 4 mm

Capacity : 8 GB.

Printing Options :

- Screen Printing



USB-09

Metal USB Flash Drive

Material : Metal (Matt Finish)

Size : 38 x 12 x 7 mm

Capacity : 4, 8, 16 or 32 GB.

Printing Options :

- Laser Markings
- Full color UV Printing (white)





USB-47

Stylish Leather USB Flash Drive

Material : Metal & Leather
Size : 59 x 28 x 18 mm
Capacity : 8 or 16 GB.

Printing Options :
• Laser Markings
• Screen Printing



USB-18

Leather with Chrome USB Flash Drive

Material : Metal & Leather
Size : 67 x 23 x 10 mm
Available Capacity : 4, 8, 16 & 32 GB.

Printing Options :
• Full Color UV Printing
• Screen Printing



USB-14

Plastic USB Flash Drive

Material : Plastic
Size : 60 x 20 mm
Capacity : 8 GB.

Printing Options :
• Full Color UV Printing
• Screen Printing



USB-4

**Metal Flip Style
USB Flash Drive**

Material : Metal
Size : 45 x 23 mm
Capacity : 8 GB.

Printing Options:
• Laser Markings
• Screen Printing



USB-23

**Mini High Class
USB Flash Drive**

White slide up plastic USB base
on a metal chrome finish body.
Material : Metal & Plastic (White)
Size : 38 x 18 mm
Available Capacity : 4, 8, 16 or 32 GB.

Printing Options:
• Full Color UV Printing
• Laser Marking
• Screen Printing



USB-5

**Metal Flip Style
USB Flash Drive**

Material : Metal
Size : 50 x 22 mm
Capacity : 8 GB.

Printing Options:
• Laser Markings
• Screen Printing



USB-16

**Rubberized ABS Plastic
USB Flash Drive**

White plastic with rubber finish,
transparent push-button to reveal USB.
Material : ABS Plastic
Size : 71 x 22 x 9 mm
Capacity : 16 GB.

Printing Options:
• Full Color UV Printing
• Screen Printing





USB-46

Key Shaped USB Flash Drive

Unique flash drives feature our popular metal USB key style flash drive combined with a handy protective leather pouch.

Material : Metal & Leather

Size : 55 x 26 mm

Available Capacity : 8 GB.

Printing Options :

- Laser Markings
- Screen Printing



USB-7

Key Shaped USB Flash Drive

Material : Metal

Size : 57 x 25 mm

Available Capacity : 4, 8 or 16 GB.

Printing Options :

- Full Color UV Printing
- Laser Markings



USB-28

Swivel Mini USB Flash Drive

Barely bigger than a coin, this mini USB drive is protected by a colorful metal swivel cap that comes in a variety of colors. With its ring attachment you can easily put it to a keychain or bag and never worry about losing your important digital data.

Material : Metal | Size : 35 x 14 mm

Available Capacity : 4, 8, 16 & 32 GB.

Printing Options :

- Full Color UV Printing
- Screen Printing
- Laser Marking

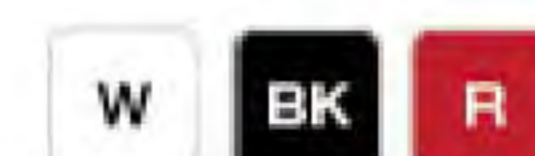

USB-43

**Matte Silver Swivel
USB Flash Drive**

Material : Metal & Plastic
 Size : 55 x 20 mm
 Available Capacity : 4 or 8 GB.

- Printing Options :
- Laser Markings
 - Full Color Printing with Epoxy
 - Screen Printing



USB-29

**USB Flash Drive
with Jewellery**

Material : Metal with Fancy Diamonds
 Size : 60 x 22 mm
 Available Capacity : 8 GB.

- Printing Options :
- Laser Markings
 - Full Color Printing with Epoxy
 - Screen Printing



USB-8

**Metal Swivel
USB Flash Drive**

Material : Metal & Plastic
 Size : 50 x 20 mm
 Available Capacity : 4 or 8 GB.

- Printing Options :
- Laser Markings
 - Full Color Printing with Epoxy
 - Screen Printing





USB-39

Swivel LED Light USB Flash Drive

Push Button to activate LED light.
Material : Plastic & Metal
Size : 60 x 30 mm
Available Capacity : 4, 8 or 16 GB.

Printing Options :

- Full Color with Epoxy (both side)



USB-54

Metal Clip USB Flash Drive

USB Metal Clips are a fantastic dual purpose USB flash drive and they make a particularly good giveaway at any event.
Material : Metal
Size : 55 x 12 x 6 mm
Capacity : 8 GB.

Printing Options :

- Laser Markings
- Screen Printing



USB-LN-003-W-H

Lanyard USB Flash Drive

The unique design of this lanyard is ideal for recipients who wear corporate ID or Tag and need to keep a flash drive in them handy at all times.
Material : Lanyard & Plastic
Capacity : 8 or 16 GB.

Printing Options :

- Heat Transfer
- Screen Printing

USB-37

Plastic USB Flash Drive with Touch screen knob.

Material : Plastic
 Size : 45 x 22 mm
 Capacity : 4, 8 or 16 GB.

Printing Options:
 • Full Color UV Printing
 • Screen Printing



USB-44

Silicone Wristband USB Flash Drive

Material : Silicone • Size : 210 x 20 mm
 Capacity : 4, 8 or 16 GB.

Printing Options:
 • Screen Printing



USB-34

Twister USB Flash Drive

Square shape USB Flash drive with twist mechanism. This twist mechanism brings the USB out when you need it and houses it back when you don't. Perfect for square shaped logos & brand.
 Material : Plastic • Size : 30 x 30 mm
 Capacity : 4, 8, 16 or 32 GB.

Printing Options :
 • Full Color with Epoxy





USB-38

Bamboo USB Flash Drive

Swivel USB flash drive manufactured from eco-friendly bamboo which is a renewable resource. A material which produces unavoidable variances in the grain pattern, colour and branding.

Material : Bamboo
Size : 65 x 18 mm
Capacity : 4 or 8 GB.

- Printing Options :**
- Laser Engraving
 - Screen Printing



USB-13

Wooden USB Flash Drive

Durable and attractive, this wood usb flash drive has an outer shell crafted from bamboo- a sustainable material that also looks good, feels smooth and is compact.

Material : Wood
Size : 60 x 30 mm
Capacity : 4 or 8 GB.

- Printing Options :**
- Laser Engraving
 - Screen Printing



USB-24

Leather Keychain USB Flash Drive

Material : Leather & Metal
Size : 110 x 28 mm
Available Capacity : 4, 8 or 16 GB.

- Printing Options :**
- Laser Engraving
 - Screen Printing

USB-25

**Leather Keychain
USB Flash Drive**

Material : Leather & Metal
Size : 80 x 20 mm
Available Capacity : 4, 8 or 16 GB.

Printing Options:
• Laser Engraving
• Screen Printing



USB-31

**Oval Swivel
USB Flash Drive**

Material : Plastic
Size : 53 x 28 mm
Available Capacity : 4 GB.

Printing Options:
• Full Color Printing with Epoxy



USB-52

**Color Changing
USB Flash Drive**

Material : Plastic & Metal
Size : 63 x 33 mm
Available Capacity : 8 GB.

Printing Options:
• Laser Engraving





OTG Technology

Data transfer between platforms without inconvenient cables.

USB OTG products can easily communicate with each other without the need of a personal computer. For instance, you can directly connect a digital camera to a mobile phone, as long as the device is both OTG-compatible.

Transfer, store and read data on mobile devices



Photo

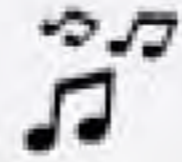

Music



Videos



Documents



USB-15

Swivel Phone USB (OTG Combo)

Material : Metal • Size : 55 x 16 mm
Capacity : 8 GB.

Printing Options :
Laser Marking or Screen Printing



USB-42

Phone USB (OTG Combo)

Material : Metal • Size : 67 x 18 mm
Capacity : 4, 8 or 16 GB.

Printing Options:
Laser Marking or Screen Printing



USB-12

Mobile & Laptop Card USB (OTG)

Material : PVC
Size : 85 x 54 mm
Capacity : 4 GB.

Printing Options :
• Full Color UV Printing

USB-22

Square Rubberized USB Flash Drive

Material : Rubber
 Size : 50 x 30 mm
 Capacity : 4, 8, 16 or 32 GB.

Printing Options :
 • Laser Marking
 • Full Color with Epoxy



USB-2

Round Rubberized USB Flash Drive

Material : Rubber
 Size : 50 x 35 mm
 Capacity : 4, 8, 16 or 32 GB.

Printing Options :
 • Laser Marking
 • Full Color with Epoxy



USB-6

Rubberized USB Flash Drive

Material : Rubber
 Size : 55 x 25 mm
 Capacity : 4, 8, 16 or 32 GB.

Printing Options :
 • Laser Marking
 • Full Color with Epoxy



USB-3

Oval Rubberized USB Flash Drive

Material : Rubber
 Size : 50 x 25 mm
 Capacity : 4, 8, 16 or 32 GB.

Printing Options :
 • Laser Marking
 • Full Color with Epoxy





USB-36

**Rectangular Mini
USB Flash Card**

Material : PVC
Size : 60 x 30 mm
Available Capacity : 4, 8 or 16 GB.

Printing Options :
• Full Color UV Printing



USB-57

**Square Mini
USB Flash Card**

Material : PVC
Size : 40 x 40 mm
Available Capacity : 4, 8 or 16 GB.

Printing Options :
• Full Color UV Printing



USB-56

**Round Mini
USB Flash Card**

Material : PVC
Size : 40 x 40 mm
Available Capacity : 4, 8 or 16 GB.

Printing Options :
• Full Color UV Printing

USB-11

PVC USB Flash Card

Card design USB Flash drive with, folding mechanism and especially designed for full color digital printing.
 Material : PVC Plastic | Size : 84 x 54 mm
 Available Capacity : 4, 8, 16 or 32 GB.

- Printing Options :
- Full Color UV Printing
 - Screen Printing



USB-11-TR
Transparent
USB Flash Card

Material : Plastic (Transparent)
 Size : 84 x 54 mm
 Available Capacity : 4, 8, 16 or 32 GB.

- Printing Options :
- Full Color UV Printing
 - Screen Printing



USB-11-M
Aluminum
USB Flash Card

Material : Aluminium
 Size : 84 x 54 mm
 Available Capacity : 4, 8, 16 or 32 GB.

- Printing Options :
- Full Color UV Printing
 - Screen Printing





Best seller Promotional Flash Drive

Swivel USB Flash Drive

Large selection of Colours from both Metal Swivel & Plastic Casing. We offer in different printing options; Laser Marking, Full Color UV Printing, Screen Printing & Full Color with Epoxy



USB-35-BL-M

Blue Swivel USB Flash Drive

Material : Metal & Plastic
 Size : 58 x 20 x 11 mm
 Available Capacity : 4, 8, 16 or 32 GB.

Printing Options :
 • Laser Marking



USB-35-BK-M

**Matte Black Swivel
USB Flash Drive**

Material : Metal & Plastic
Size : 58 x 20 x 11 mm
Available Capacity : 4, 8, 16 or 32 GB.

Printing Options :
• Laser Marking



USB-35-S

**Matte Silver Swivel
USB Flash Drive**

Material : Metal & Plastic
Size : 58 x 20 x 11 mm
Available Capacity : 4, 8, 16 or 32 GB.

Printing Options :
• Laser Marking
• Screen Printing



USB-35-W

**White Swivel
USB Flash Drive**

Material : Metal & Plastic
Size : 58 x 20 x 11 mm
Available Capacity : 4, 8, 16 or 32 GB.

Printing Options :
• Full Color UV Printing
• Screen Printing





USB-35-S-1L (1 side print)
USB-35-S-2L (2 side print)

**Silver Swivel
USB Flash Drive**

Material : Metal & Plastic
 Size : 58 x 20 x 11 mm
 Available Capacity : 4, 8, 16 or 32 GB.

Printing Options :
 • Full Color Digital Printing with Epoxy



USB-35-SS

**Shiny Silver Swivel
USB Flash Drive**

Material : Metal & Plastic
 Size : 58 x 20 x 11 mm
 Available Capacity : 4, 8, 16 or 32 GB.

Printing Options :
 • Laser Marking
 • Screen Printing



USB-35-SG

**Shiny Gold Swivel
USB Flash Drive**

Material : Metal & Plastic
 Size : 58 x 20 x 11 mm
 Available Capacity : 4, 8, 16 or 32 GB.

Printing Options :
 • Laser Markings
 • Screen Printing





Promotional USB Pens

Brings cutting edge technology and sophistication together to simplify your life

SHINY SILVER EFFECT

Info :
This pen has a rubberized coating on the barrel showcasing a chrome effect after laser engraving.



Info :
This pen has a soft matte texture barrel for single color or multi color printing.

FULL COLOR LOGO

USB-49

Rubberized Barrel USB Pen

Rubberized Texture Barrel
Engravable with Shiny Silver Effect
Available Capacity : 16 GB.

SL

BK



USB-50

Promotional USB Pen

Rubberized Texture Clip
Chrome Metal Barrel Design
Engravable with Shiny Silver Effect
Available Capacity : 8 GB.

Printing Options :
- Laser Marking (Shiny Silver)



Info :
This pen has a rubberized coating on the clip showcasing a chrome effect after laser engraving.

SHINY SILVER EFFECT

USB-51

Promotional USB Pen

Rubberized Texture Clip
Plastic Matte Silver Barrel Design
Engravable with Shiny Silver Effect
Available Capacity : 8 GB.

Printing Options :
- Laser Marking (Shiny Silver)



Info :
This pen has a rubberized coating on the clip showcasing a chrome effect after laser engraving.

SHINY SILVER EFFECT

USB-30

**Silver USB Pen
with Stylus touch screen**

A real all-rounder! Ballpoint pen with stylus and additional integrated USB stick. The barrel is made of metal has a twist mechanism for the writing lead. Size : 136 x 14 x 14 mm Available Capacity : 4, 8 or 16 GB.

- Printing Options :**
- Laser Marking
 - Screen Printing



USB-60

**Rubberized USB Pen
with Stylus touch screen**

Rubberized Texture Barrel
Engravable with Shiny Silver Effect
Available Capacity : 16 GB.

- Printing Options :**
- Laser Marking (Shiny Silver)



**MULTI FUNCTION TIP
STYLUS TOUCH NOB & PEN**



USB-61

4 In 1 : Multi-function USB Pen

Pen with USB Flash Drive, Mobile Holder, & Screen Cleaner, Equipped with Schneider Refill.
 Material : Metal & Plastic
 Available Capacity : 4, 8, 16 or 32 GB.

- Printing Options :
- Full Color UV Printing on Clip
 - Laser Marking on Barrel



For your Corporate or even Personal Use.



USB-32

High Quality Metal USB Pen

Metal Pen with Chrome Clip & Tip
 Available Capacity : 4, 8, 16 or 32 GB.

- Printing Options :
- Laser Marking
 - Full Color UV Printing



USB-53

Multi-function : 5 In 1 Promotional USB Pen

5 Functions in 1, durable and reliable for daily use
 Money checker, Laser, White LED, Ballpoint Pen, USB Drive
 Easy to use. Just plug and play into a USB port
 Available Capacity : 8 GB.

- Printing Options :
- Laser Marking
 - Screen Printing



USB-41

Multi-function : 3 In 1 Crystal Stylus USB Pen

Metal Pen with Crystal & Stylus
 Available Capacity : 8 GB.

- Printing Options:
- Full Color UV Printing
 - Laser Marking
 - Screen Printing





USB-MB

A5 PU Notebook with USB Flash Drive

Size : A5 (140 x 210 x 20 mm)
Available Capacity : 4, 8, 16 or 32 GB.

Printing Options : Full Color UV Printing
Screen Printing, Debossing / Deboss with foiling



USB Flash Drive Packing Options

Available in Different Sizes, Material & Shapes

USB-PB

USB PU Leather Zippered Pouch

Material : PU
Size : 80 mm



565-9-S

Leather Pouch

Material : Leather
Size : 70 x 40 mm



565-9

Leather Pouch for Card USB

Material : Leather
Size : 100 x 65 mm



USB-35-PB

Plastic Packing for Swivel Flash Drive

Material : Plastic with foam for USB protection.
Size : 95 x 45 x 20 mm



565-8

Plastic Packing for USB Flash Card

Material : Plastic with clip USB protection
Size : 72 x 105 mm



706

Aluminum Window USB Packing Box

Silver & Black - with transparent window.
Size : 100 x 70 mm, 25 mm height
Black inlay with string interior to protect the USB stick.

Printing Options : Screen Printing



USB-B-CL

Aluminum Window USB Packing Box

Silver - with transparent window.
Size : 115 x 85 mm, 22 mm height .
With a loose black foam inlay to protect the USB stick.

Printing Options : Screen Printing

264

Aluminum Rectangular Box

Box for Pen & USB Flash Drive,
This aluminum gift set has a logo space
on top of the lid which allows a
corporate logo to be printed.

Printing Options :
• Full color printing with epoxy





maxema®

**PLAY
THE
COLOR
YOU
WANT**

Maxema

Just a Pen?



Production

Our highly automated assembly lines guarantee rapid, extremely competitive manufacturing times: depending on the model, our machinery can assemble from 2,000 to 6,000 pcs per hour. Automation also means guaranteeing functionality: strict quality checks make sure that all our pens operate perfectly at each stage of their assembly.

Planning

Not everyone knows that it can take more than a year to create a new pen in which every detail is handled with meticulous care. Creating the moulds for each component of the pen is a highly complex operation: a mistake of even a hundredth of a millimetre could jeopardise its operation. This is why all our pens are designed and manufactured entirely in our only Italian premises, where we are able to monitor every stage: from the first prototypes right down to marketing the finish products.

Design

The design of our pens is the outcome of ongoing styling research: the lines and colours are inspired by the trends of the day. A promotional pen must attract and excite, as well as being a quality support for the message it is delegated to convey. Appearance, originality, quality: everything must be perfectly balanced to make a pen worthy to carry a uniquely special company image.

Quality

Attention to quality starts with the strict selection of raw materials: the plastic, refills and inner springs come exclusively from Italian or German suppliers, who guarantee their quality and reliability. The plastic for our pens comes from top quality, non-toxic ABS, which is highly resistant to knocks and sudden changes in temperature, guaranteeing excellent glossiness & high colour stability. The refills respect EU Directives for hazardous substances (2004 / 73 / EC, 67 / 548 / EEC and 2006 / 1907 / EC - REACH) and the American TSCA (Toxic Substances Control Act): so all the inks are non-toxic.

Sustainability

Only a quality pen can really enhance a message, growing a brand's visibility and, why not, helping to limit the pollution of the planet. Plastics pollute: if a pen is high quality it will have a long average lifespan that will lead it to change hands more than once, so limiting the waste that comes from the immediate discarding of faulty pens. It is much better to invest in quality pens, maybe choosing to limit the quantity rather than running the risk of compromising your image and spreading the irresponsible use of plastic pens. The longer a pen's life is, the less it pollutes the environment.

Customisation

Once assembled, the pen is ready to be "dressed" with a logo or a message: our graphics office works on digital simulations to assess the possible alternatives, suggesting new proposals so that the most suitable combination can be found. Like a tailor's shop, the customer can try different sizes, colours and positions until the suit adapts perfectly to his needs. Only then does the pad or silk-screen printing stage begin, using highly resistant paints, after which the pen is finally ready to travel the world with its precious message: your image.

Responsibility

The certificate of origin for our pens also guarantees that no child labour is involved in their manufacture, nor working conditions that do not respect workers' basic rights. We demand the same guarantee from our Italian and German raw materials suppliers. Even a pen can help to spread the culture and respect of the dignity of workers.

“A Significant step forward toward the use of safe plastic.”

“Made from a special plastic, suitable for use in toy manufacture.”



Antibacterial

It is made of **antibacterial plastic** containing a special additive which releases silver ions that prevent bacteria from colonising the surface of the pen.



Really Safe

The plastics employed with **European and American FDA food contact regulations.**

LOVING
NATURE

Antibatterica,
atossica e sostenibile.
Una penna che dura
ama la natura.



CLP compliant

It is rated as **non hazardous** the Regulation on Classification, Labelling and Packaging.





Nature friendly

Made of non-toxic plastics, it has been **designed to have a long life** and to minimize the risk of harmful substances being released into the environment.

Using a pen for as long as possible helps to reduce pollution and enables us to give full expression to the concept of promotion.



Green Chemical

It does not contain dioxin, phthalates, bisphenol A, antimony, arsenic, barium, cadmium, chrome, mercury, lead, polybrominated biphenyls (PBBs), polybrominated diphenyl ethers (PBDEs) or deca-BDE, and **conforms to RoHS**



Looking to the future

Looking to the future, Made of plastic suitable for toy manufacture (according to European standard EN 71-03 and U.S. FDA regulations).



“ Design that combines safety and environment friendliness.”

Antibacterial, non-toxic and sustainable.
A pen that lasts is a pen that loves nature.

Icon green

MAX-IG2C

solid white with glossy finish

**Made of special plastic used
to manufacture children's toys.**



01

Tag green

MAX-TA2B

solid white colour barrel and clip with glossy finishes

**Green Chemical plastic
releases silver ions that have
an anti-bacterial function.**



01

Tag green

MAX-TA2-CB

solid colours barrel and upper plug,
solid white clip, glossy finishes



AVAILABLE COLOURS



FEATURES

- Twist-action
- Made of non-toxic, highly resistant ABS plastic
- Glossy textured barrel
- X-20 refill, Blue Ink (Black Optional)

Zink

MAX-Z1-C

solid colours with glossy finish

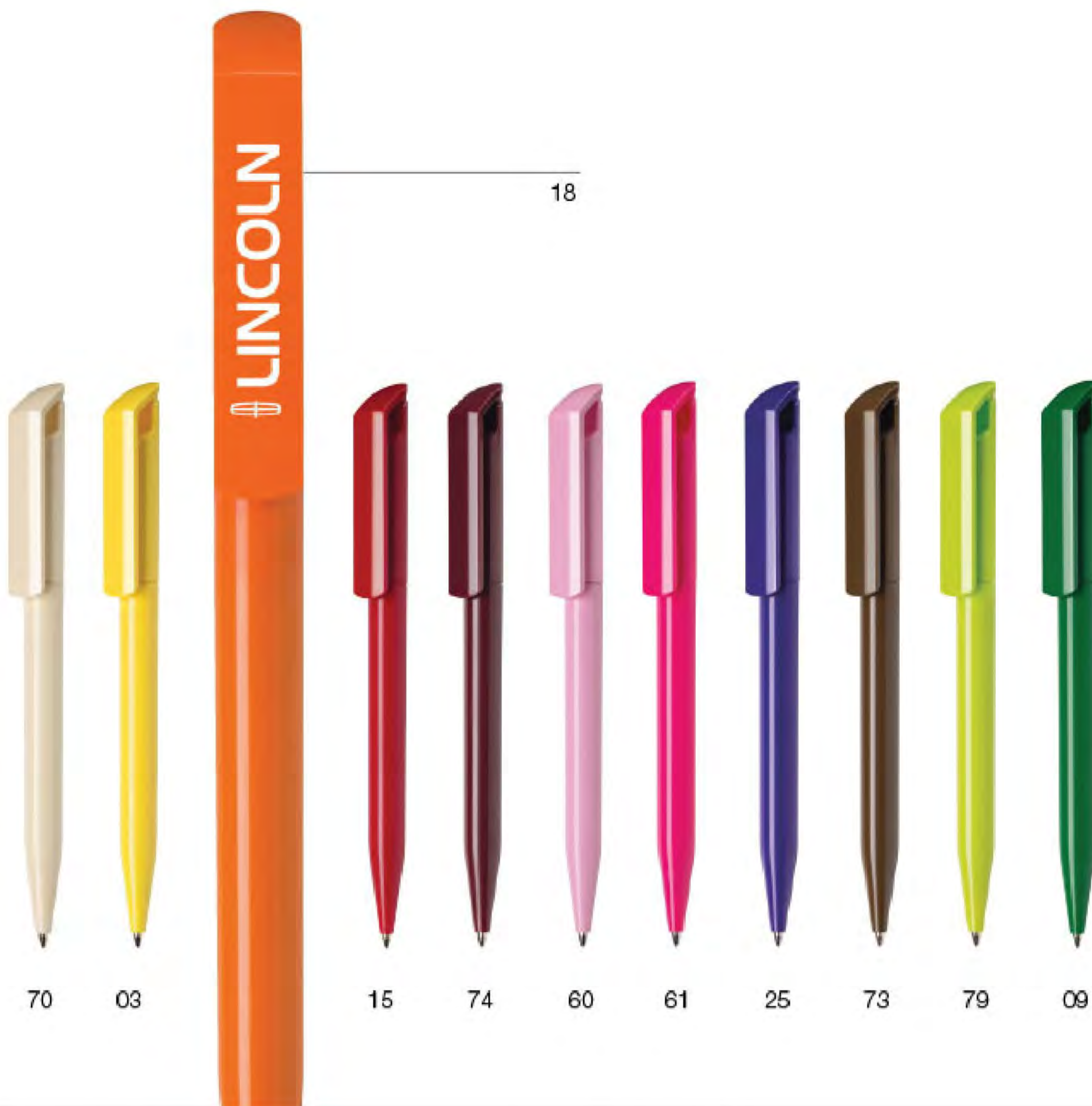

AVAILABLE COLOURS



FEATURES

- Twist-action
- made of non-toxic, highly resistant ABS plastic
- Glossy textured barrel
- Jumbo refill, Blue Ink

Solid, sturdy architecture for a profile of geometric precision.

A pen with a clean-cut profile and strong personality.



75

27

64

77

12

22

05

04

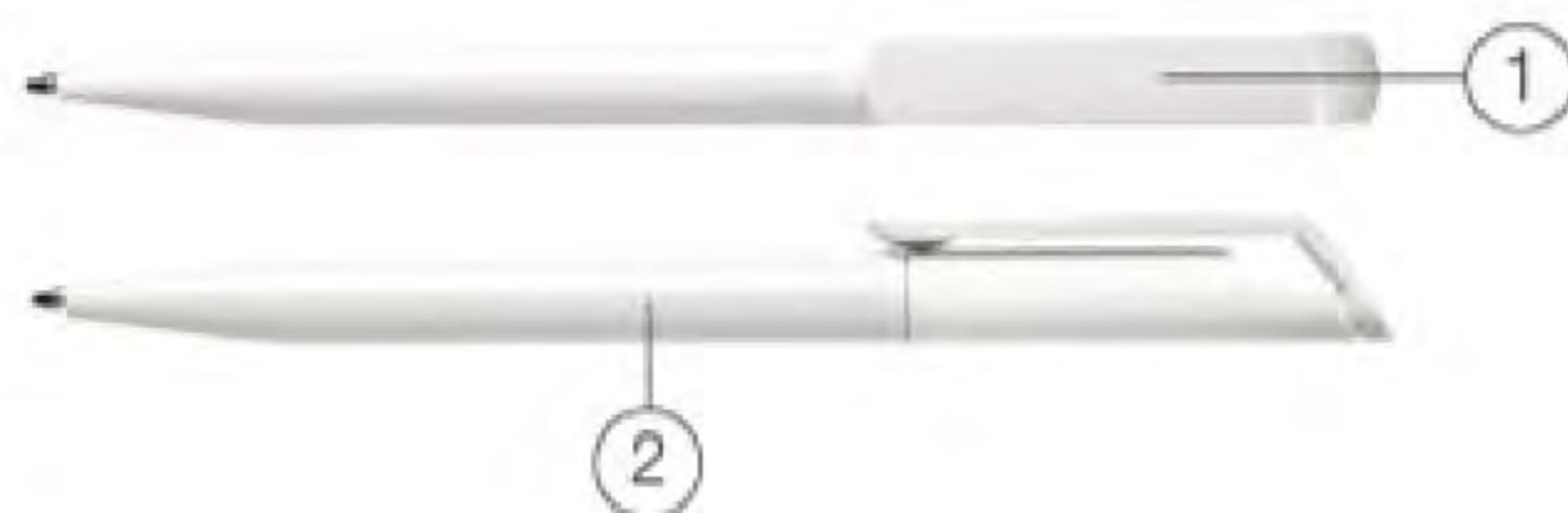

BRANDING AREA

- (1) Clip Area : 40 x 7 mm
Full Color UV Printing / Pad Printing
- (2) Barrel Area : 50 x 5 mm
Full Color UV Printing / Pad Printing

Zink

MAX-Z1-30

transparent colours with glossy finish

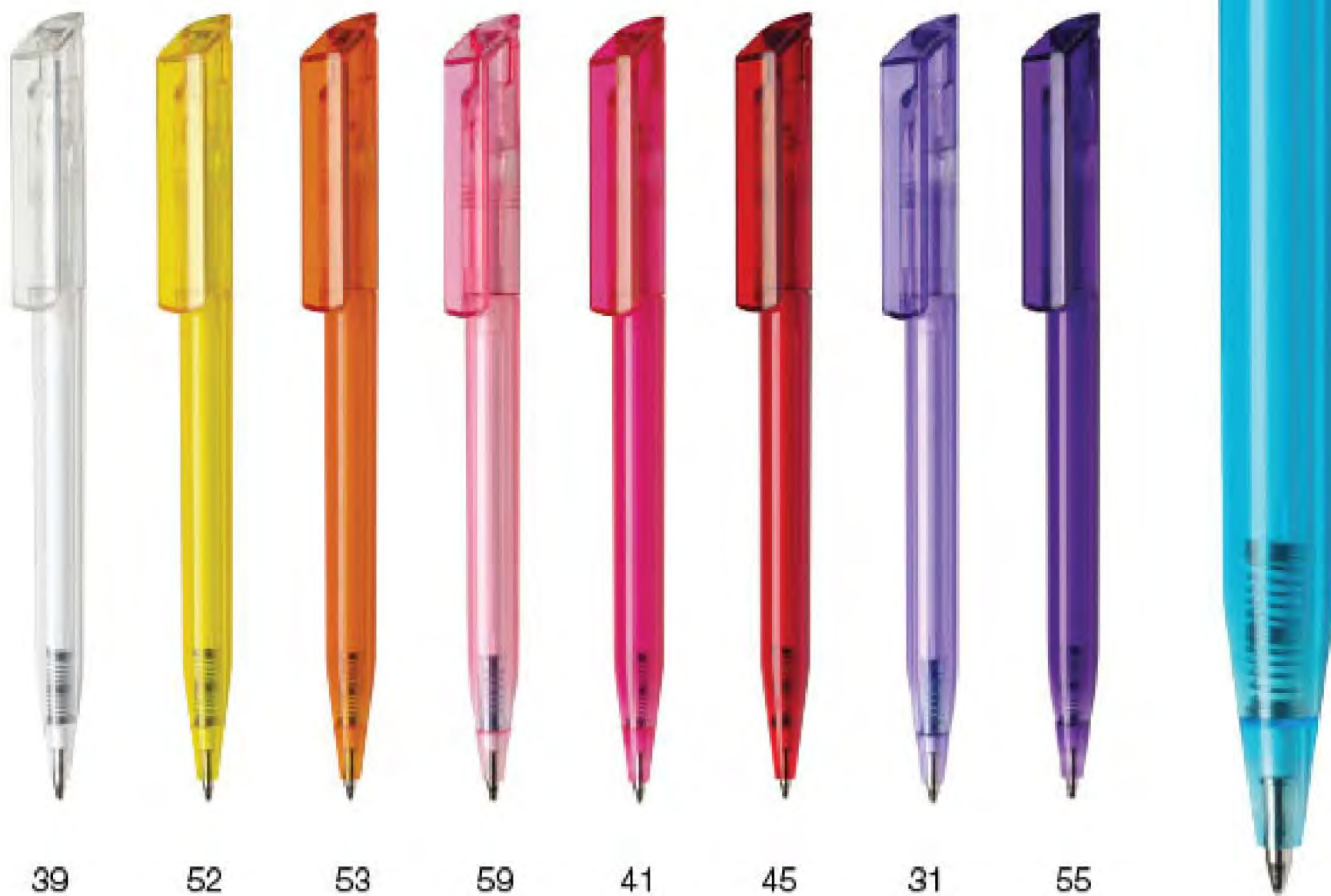

39

52

53

59

41

45

31

55

AVAILABLE COLOURS - TRANSPARENT



FEATURES

- Twist-action
- made of non-toxic, highly resistant ABS plastic
- Transparent material
- Jumbo refill, Blue Ink

**Its sturdy structure is offset by the
slim, streamlined barrel.**

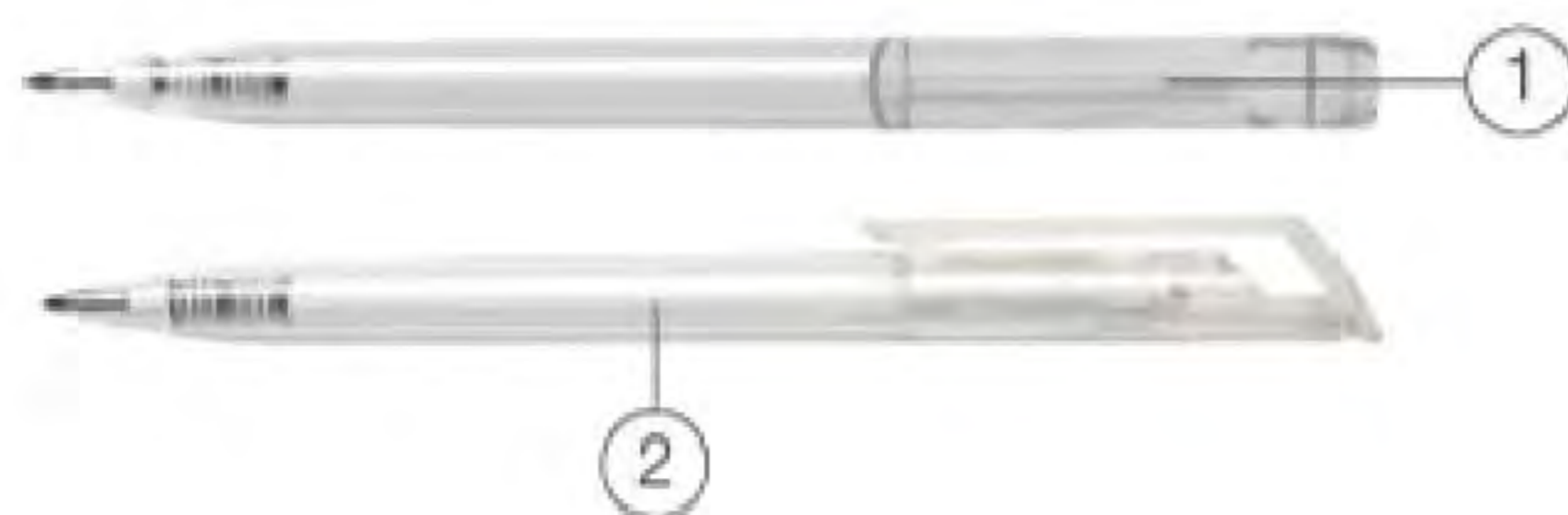
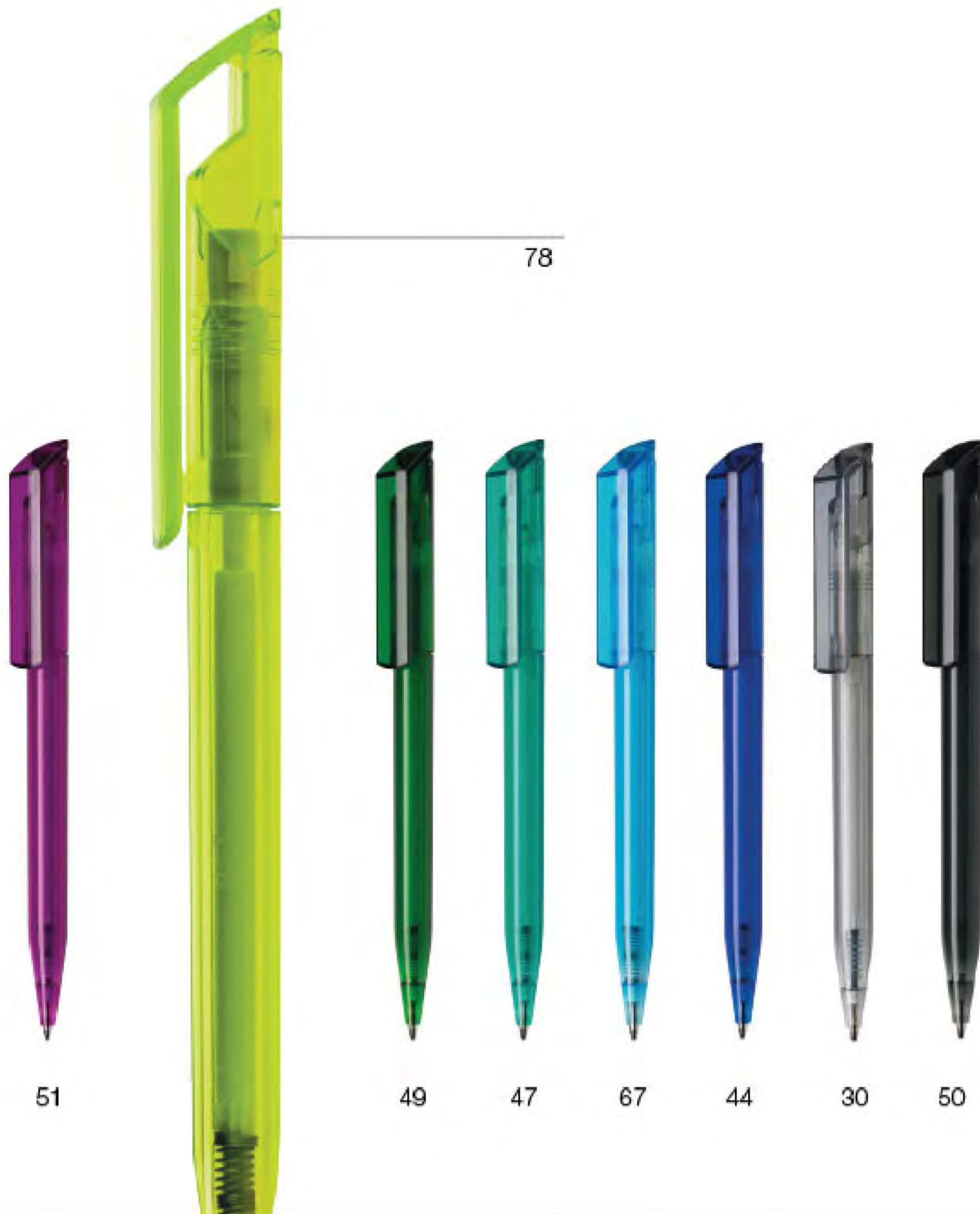

BRANDING AREA

- (1) Clip Area : 40 x 7 mm
Full Color UV Printing / Pad Printing
- (2) Barrel Area : 50 x 5 mm
Full Color UV Printing / Pad Printing

Bay MAX-BM

solid colours with matt finish



AVAILABLE COLOURS



FEATURES

- Twist-action
- made of non-toxic, highly resistant ABS plastic
- Matte textured barrel
- X-20 refill, Blue Ink

Delicately refined matte finish in **22 colours.**

Casual and Attractive, Draws attention for its simplicity.

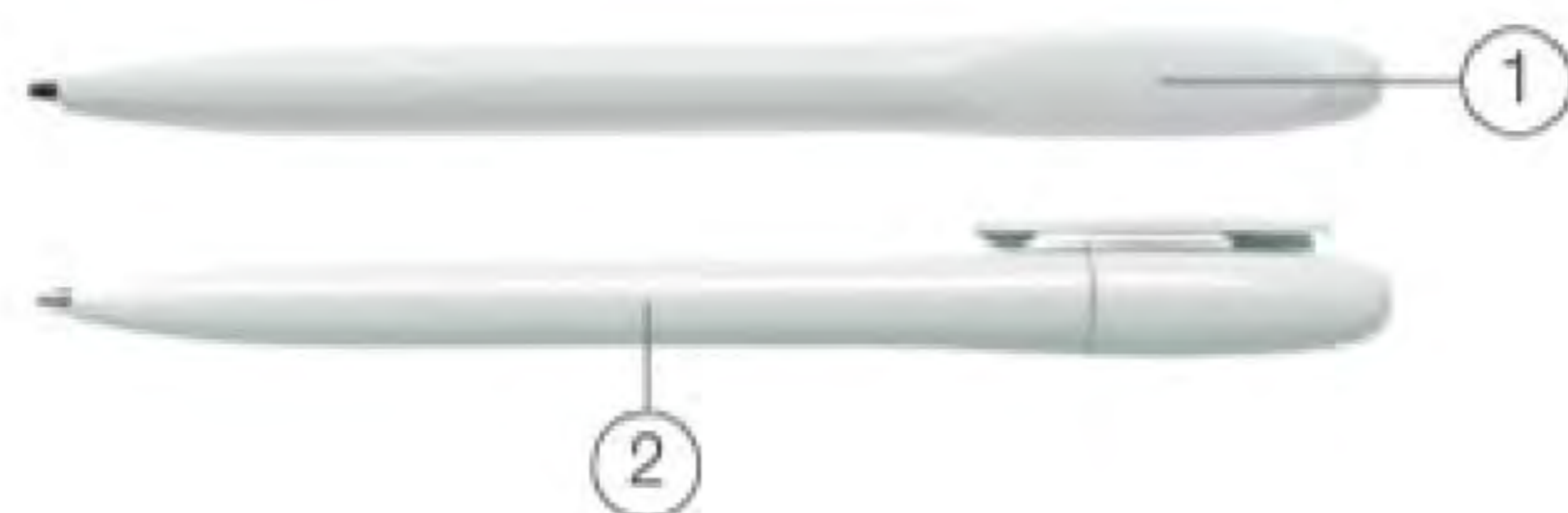
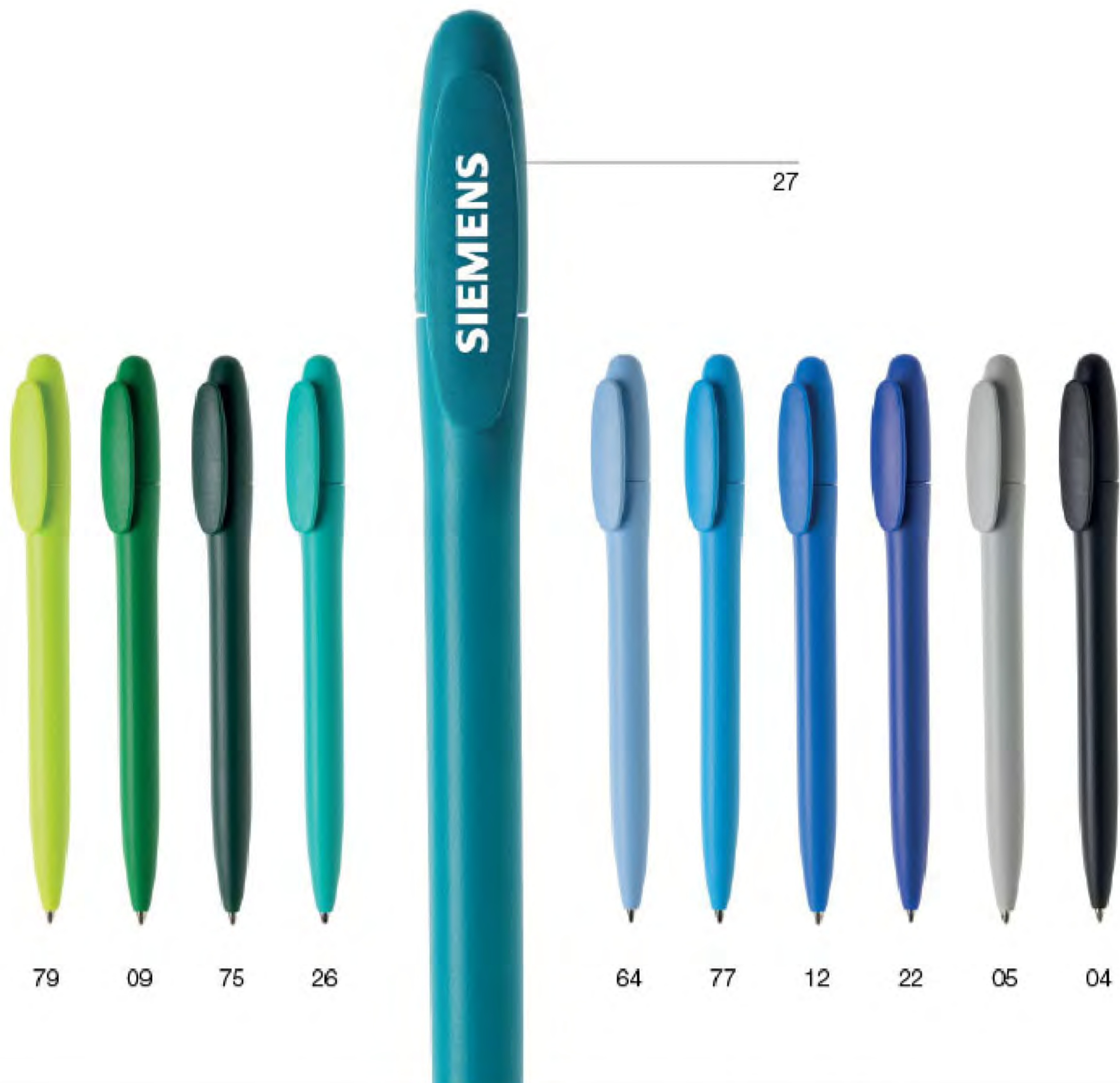

BRANDING AREA

- (1) Clip Area : 28 x 7 mm
Full Color UV Printing / Pad Printing
- (2) Barrel Area : 50 x 5 mm
Full Color UV Printing / Pad Printing

Bay

B500 - FROST

transparent colours with matt finish



AVAILABLE COLOURS



FEATURES

- Twist-action
- made of non-toxic, highly resistant ABS plastic
- Frosted textured barrel
- X-20 refill, Blue Ink

Dot**MAX-D1-BCR**

solid white colour barrel and clip with glossy finish,
solid glossy colour little sphere, chromed push-button

**Dot****MAX-D1-CGOLD**

solid colour barrel and clip with glossy finish,
solid glossy colour little sphere, gold plated push-button

**BRANDING AREA**

(1) Clip Area : 40 x 7 mm
Full Color UV Printing / Pad Printing

Dot

D1-MATT

solid colours with matt finish,
solid glossy colour little sphere

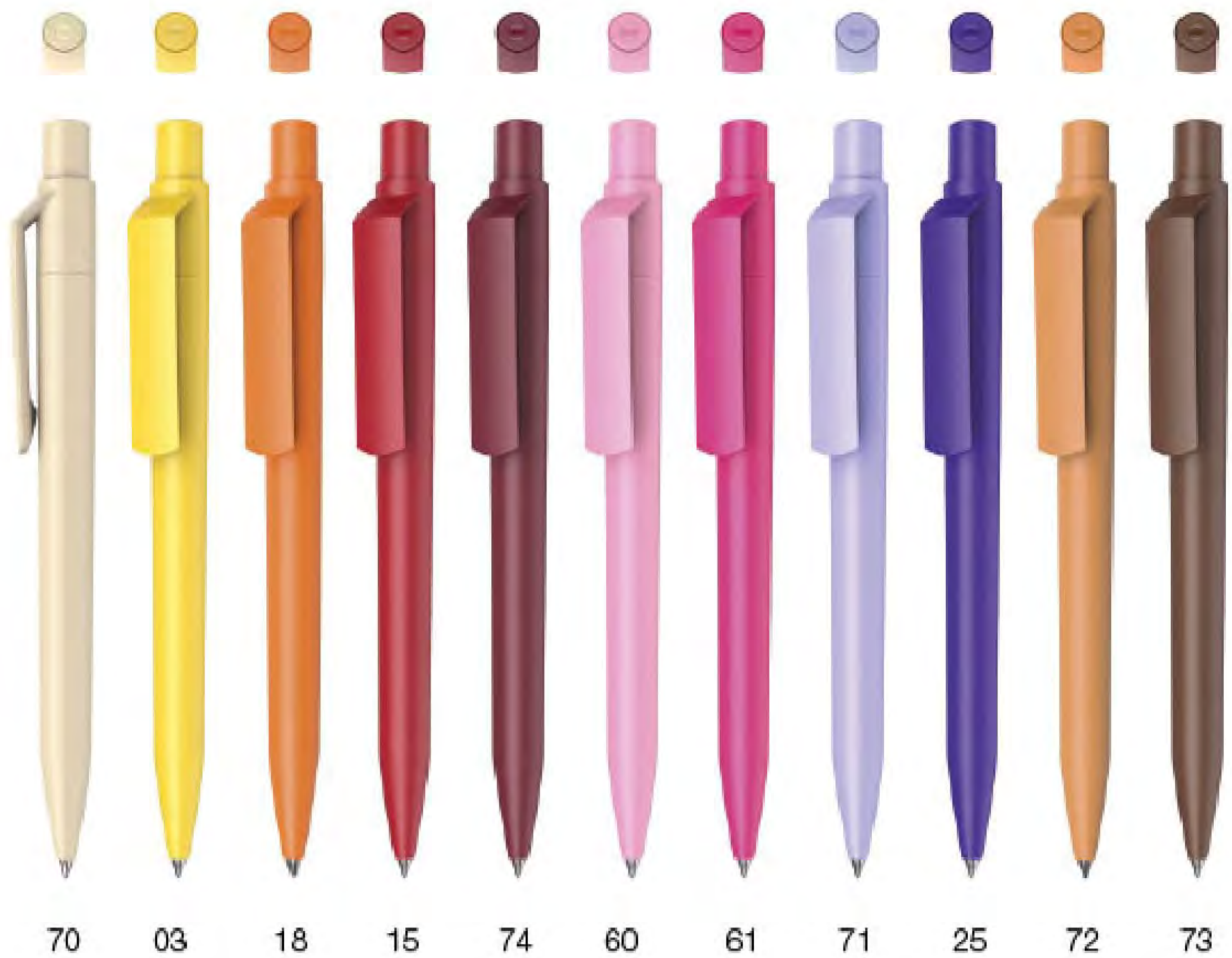

AVAILABLE COLOURS



FEATURES

- Retractable with return spring
- made of non-toxic, highly resistant ABS plastic
- Barrel is matt textured
- Jumbo refill, Blue Ink (Black optional)

**Attractive and refined:
the new integral matt finish.**

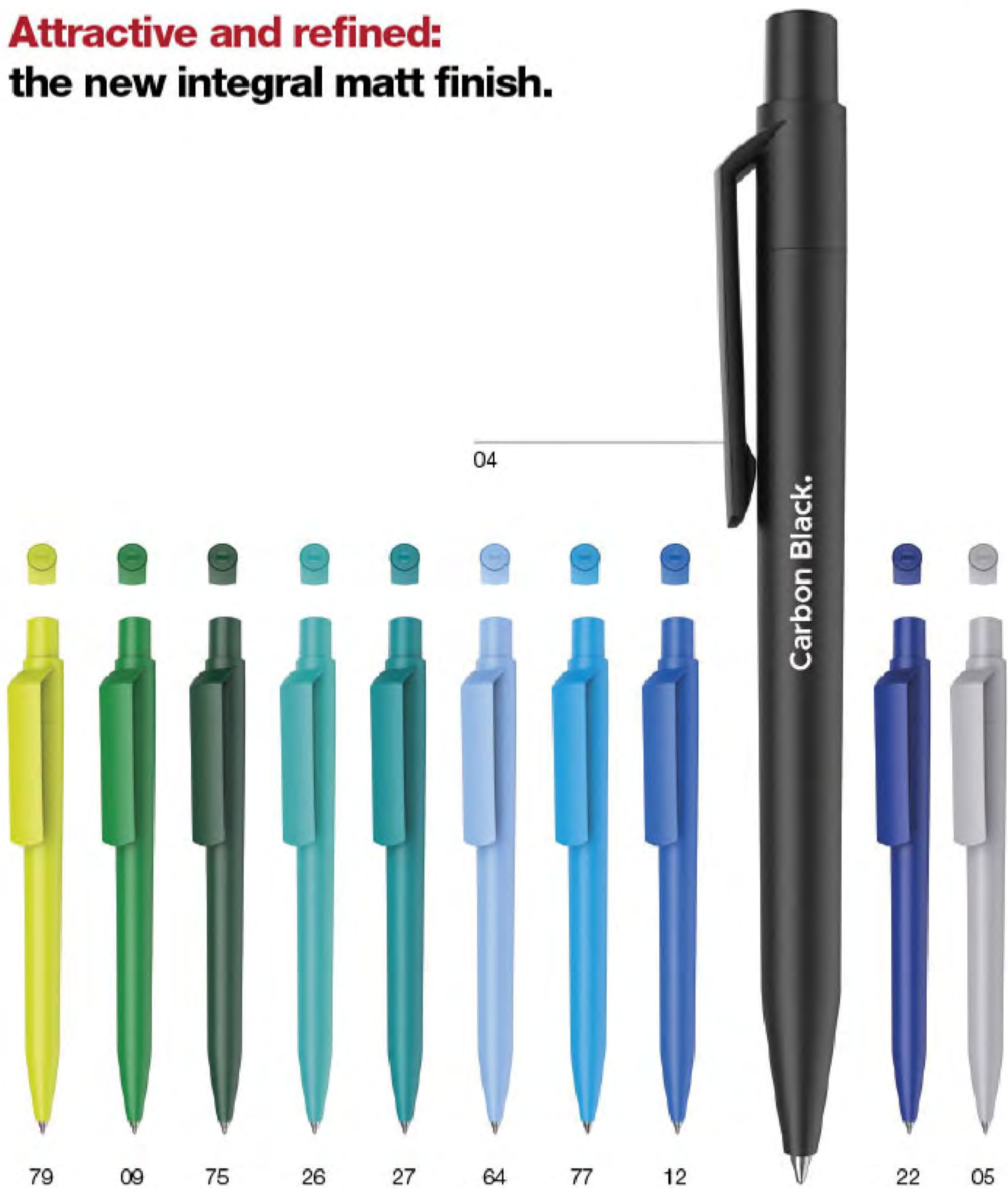

BRANDING AREA

- (1) Clip Area : 40 x 9 mm
Full Color UV Printing / Pad Printing
- (2) Barrel Area : 50 x 5 mm
Full Color UV Printing / Pad Printing

Dot

D1-GOM CB CR

solid colour barrel with rubber finish, white clip
solid glossy colour sphere, chromed push-button

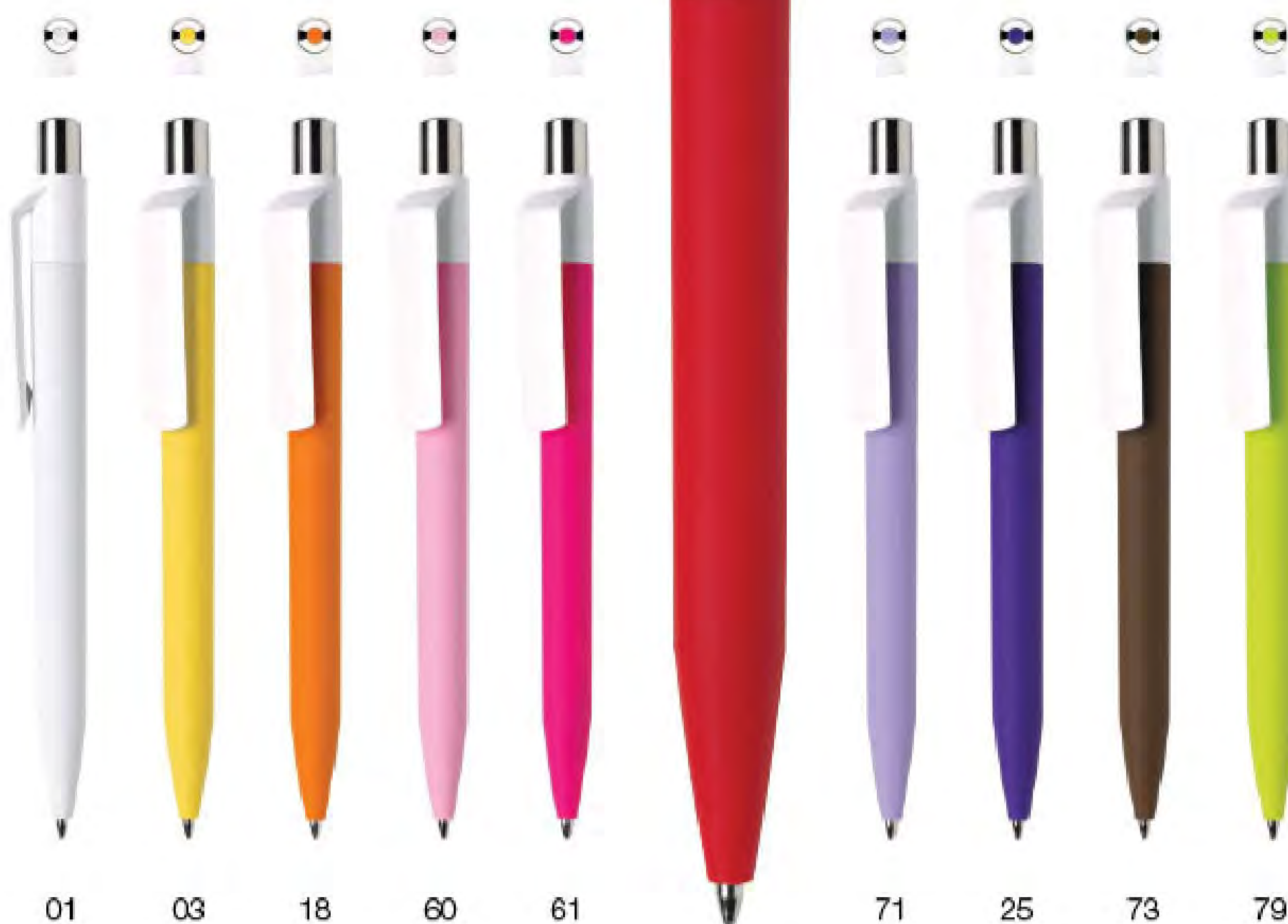
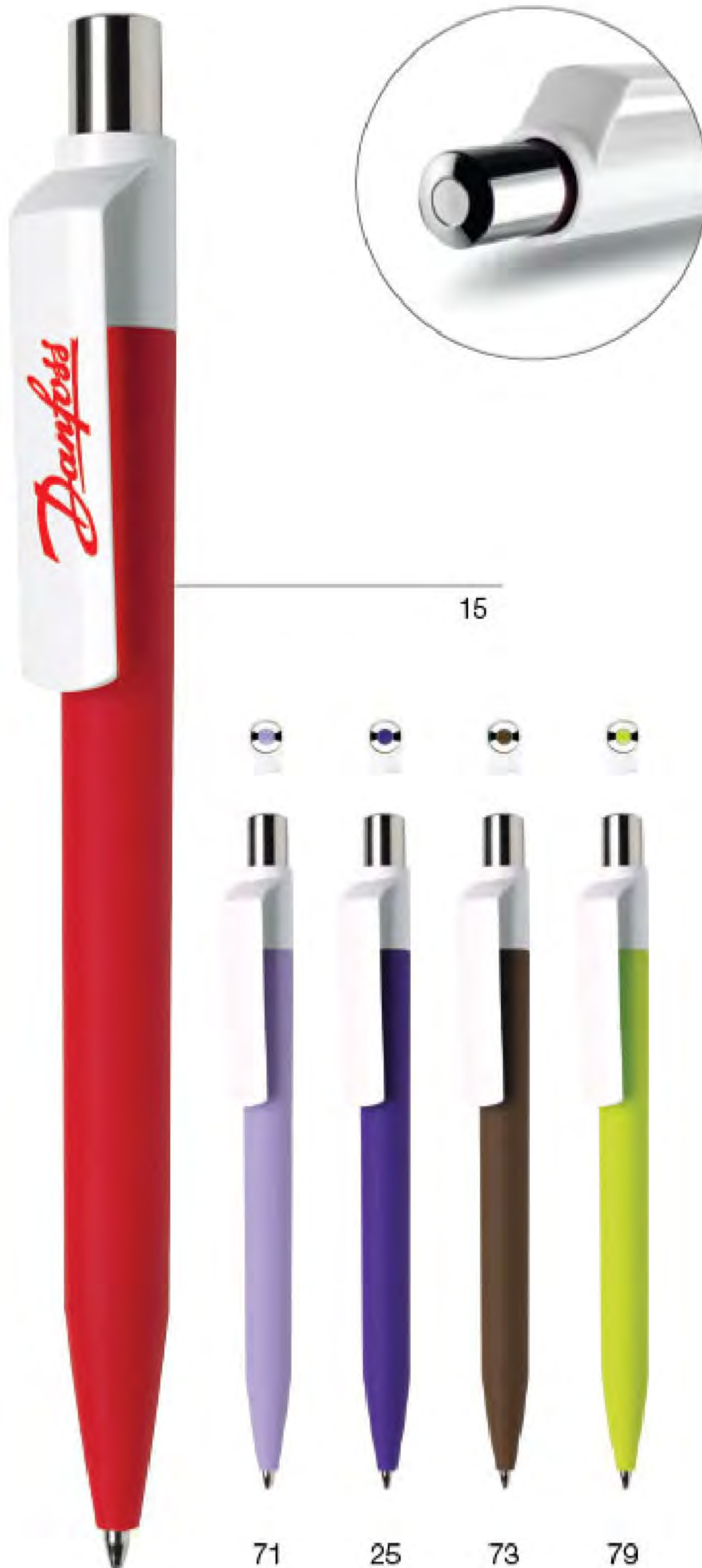

AVAILABLE COLOURS



FEATURES

- Retractable with return spring
- made of non-toxic, highly resistant ABS plastic
- galvanic process used to chrome ABS push-button
- Jumbo refill, Blue ink (Black optional)

A pen that reveals its **originality in its details.**

Different from the rest, full stop

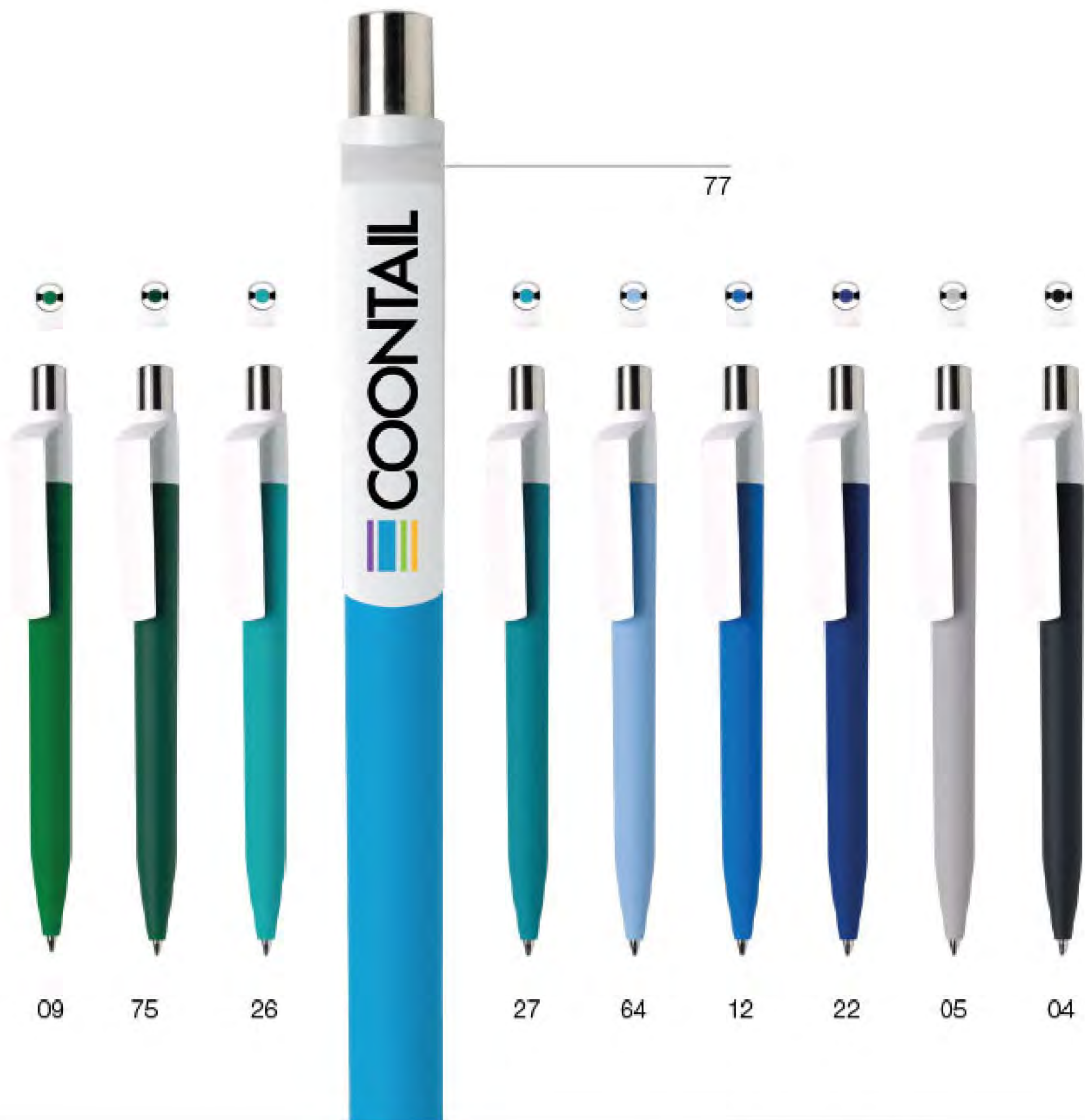

09

75

26

27

64

12

22

05

04

77



BRANDING AREA

(1) Clip Area : 40 x 7 mm
Full Color UV Printing / Pad Printing

Dot

MAX-D1-GOM30

solid colour barrel with rubber finish, transparent colour clip with glossy finish, solid glossy colour little sphere, chromed push-button



AVAILABLE COLOURS - TRANSPARENT



FEATURES

- Retractable with return spring
- made of non-toxic, highly resistant ABS plastic
- galvanic process used to chrome ABS push-button
- Jumbo refill, Blue Ink (Black optional)



37

38

78

49

67

34

30

50

31



BRANDING AREA

(1) Clip Area : 40 x 7 mm
Full Color UV Printing / Pad Printing

Flow Pure MAX-F2P-MATT

solid colours with matt finish



AVAILABLE COLOURS



FEATURES

- Twist-action
- made of non-toxic, highly resistant ABS plastic
- Matte textured barrel
- Jumbo refill, Blue ink

**All the expressive force of colour
in a monochrome version.**

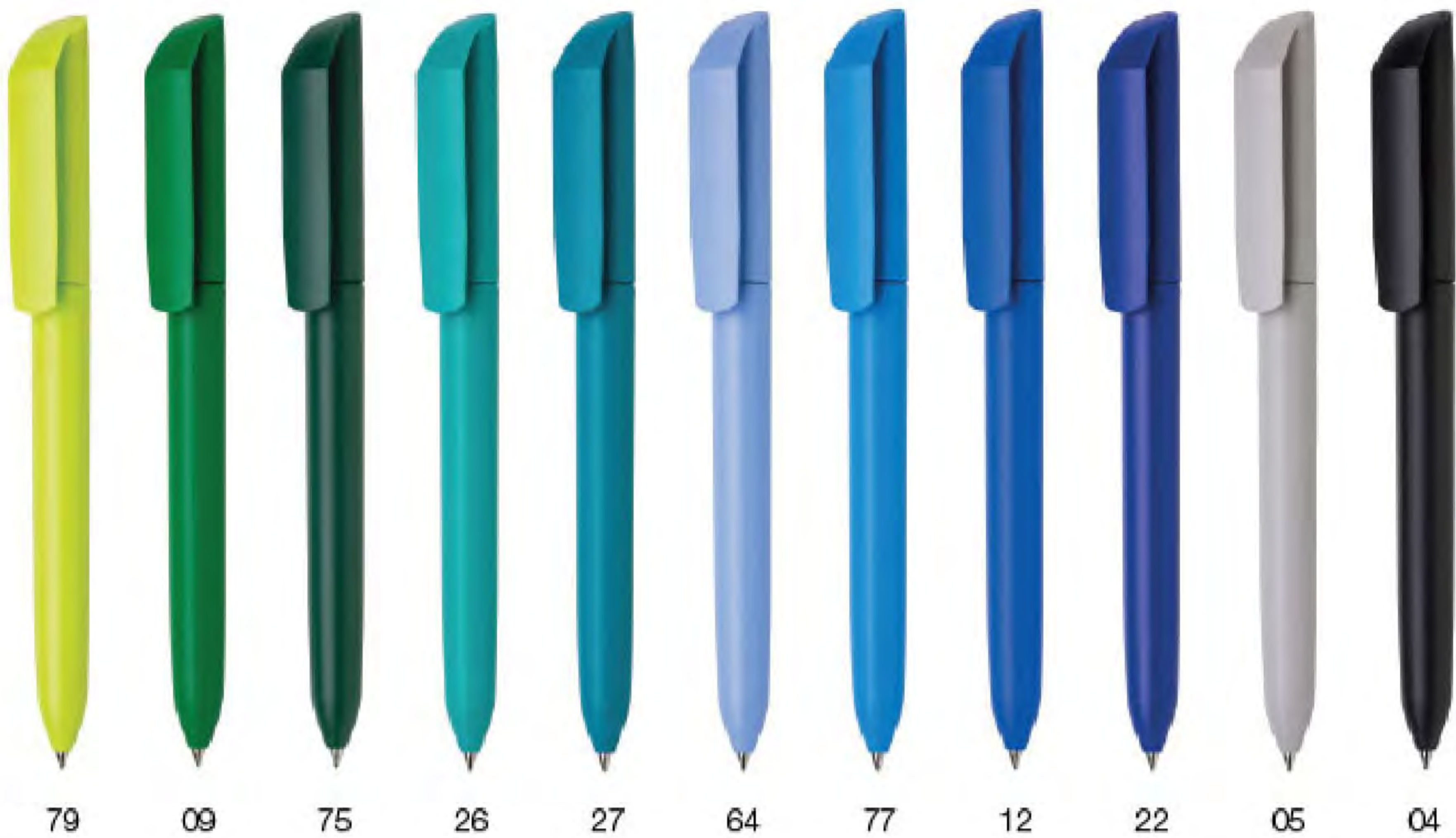

BRANDING AREA

- (1) Clip Area : 40 x 7 mm
Full Color UV Printing / Pad Printing
- (2) Barrel Area : 50 x 5 mm
Full Color UV Printing / Pad Printing

Flow Pure

MAX-F2P-MATT-CB

solid colour barrel and cap, solid white colour clip, matt finishes



AVAILABLE COLOURS



FEATURES

- Twist-action
- made of non-toxic, highly resistant ABS plastic
- Matte textured barrel
- Jumbo refill, Blue Ink

Matt finish and white clip for maximum freedom of personalisation.

Free from Extra



BRANDING AREA

- (1) Clip Area : 40 x 7 mm
Full Color UV Printing / Pad Printing
- (2) Barrel Area : 50 x 5 mm
Full Color UV Printing / Pad Printing

Flow Texture MAX-F1-GOM

solid colour barrel with rubber finish, solid glossy white colour clip,
textured solid colour cap with matt finish, chromed tip



71

03

18

15

74

60

61

25

73

79

AVAILABLE COLOURS



FEATURES

- Twist-action
- made of non-toxic, highly resistant ABS plastic
- galvanic process used to chrome tip
- Jumbo refill, Blue ink

Textured with small hexagonal cells that recall a honeycomb: a dynamic **design of visual and tactile elegance.**

Free from Extra

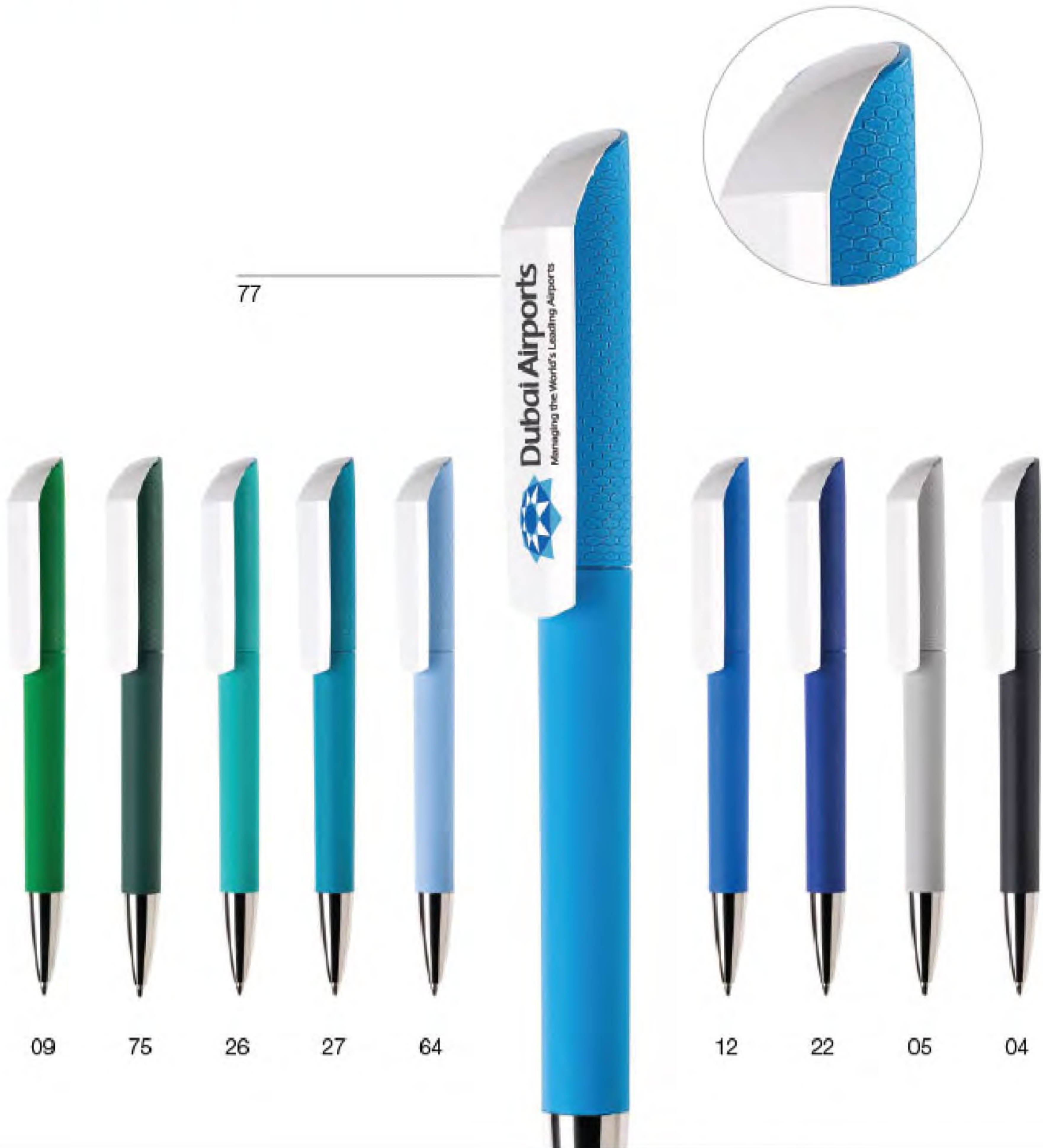

BRANDING AREA

(1) Clip Area : 40 x 7 mm
Full Color UV Printing / Pad Printing

View

MAX-V1-CCR

solid colours with glossy finish,
metal chrome finish clip, chromed tip



AVAILABLE COLOURS



FEATURES

- Twist-action
- made of non-toxic, highly resistant ABS plastic
- galvanic process used to chrome tip
- Jumbo refill, Blue ink

The sleek design of the cap adds elegance and balances the large clip.

Decisive personality

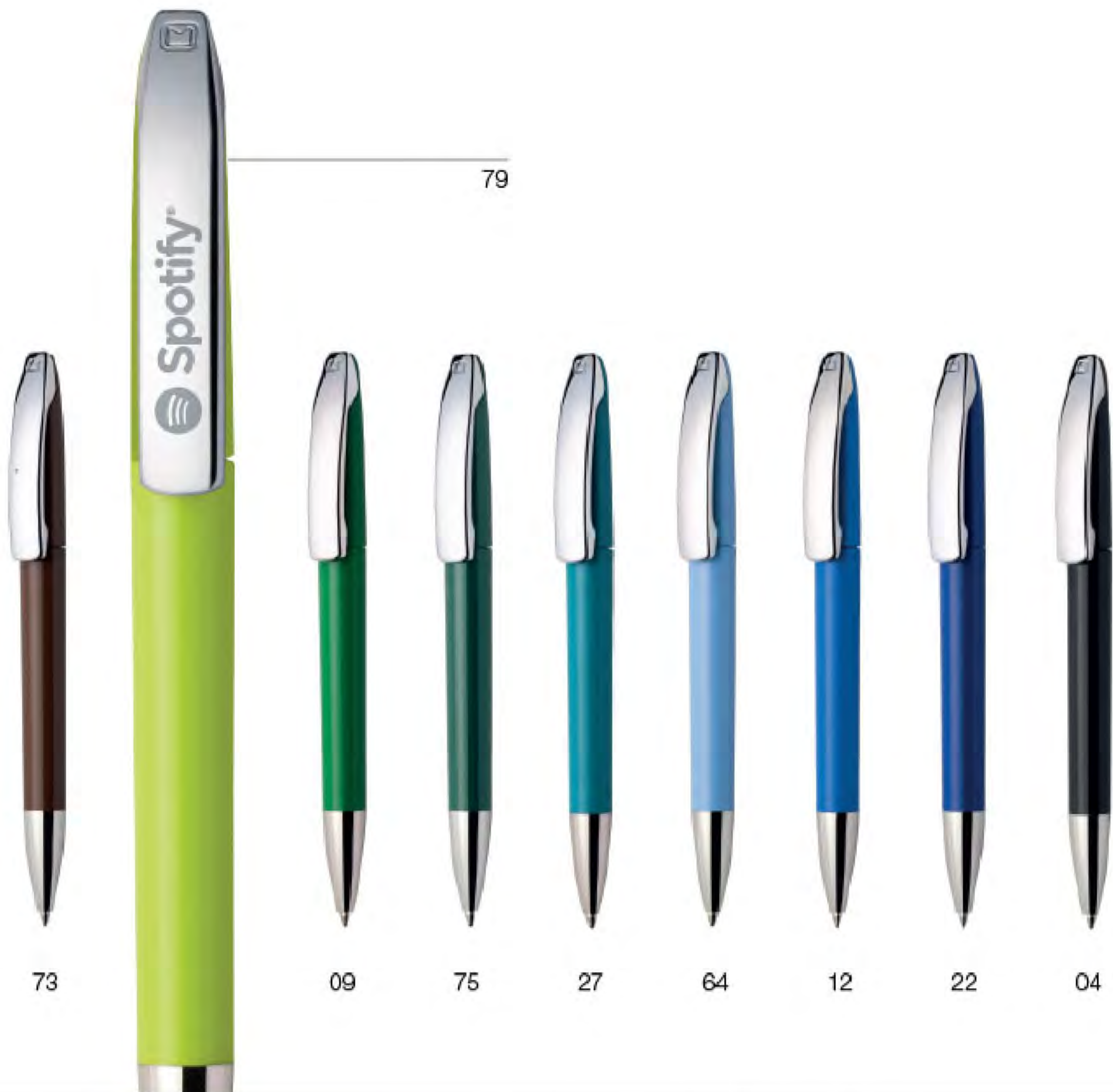

BRANDING AREA

- (1) Clip Area : 40 x 7 mm
Laser Markings / Pad Printing
- (2) Barrel Area : 50 x 5 mm
Full Color UV Printing / Pad Printing

Ethic

MAX-ET-FLAG

solid colours with glossy finish, metal
chrome finish clip, chromed tip



UAE

Kuwait

Oman

KSA
Pakistan
Nigeria

Qatar

Bahrain

Iran

Iraq

India

Kenya



BRANDING AREA

(1) Barrel Area : 40 x 5 mm
Full Color UV Printing / Pad Printing

Ethic MAX-ET-B

solid colours with glossy finish, metal
chrome finish clip, chromed tip

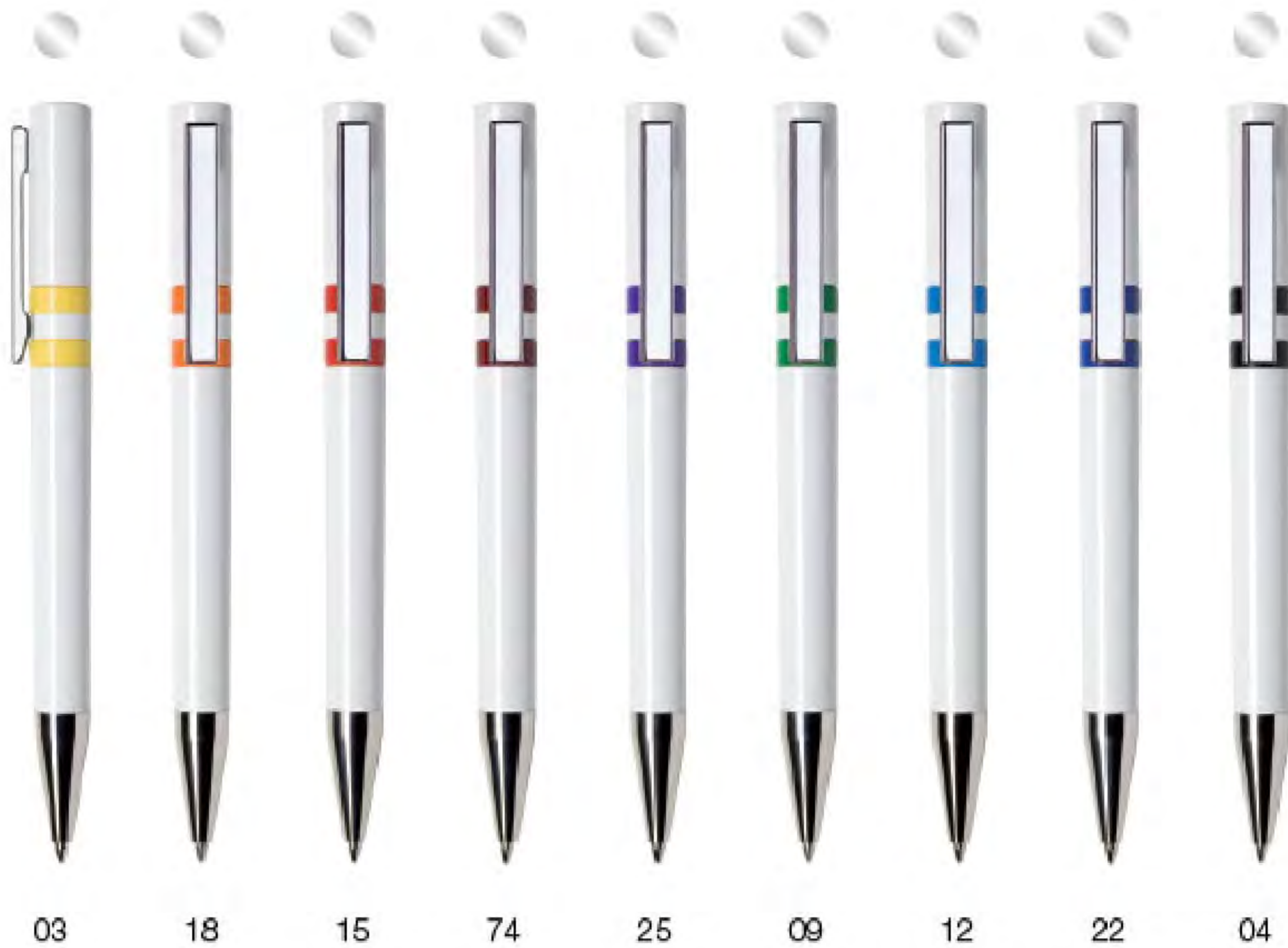

BRANDING AREA

(1) Barrel Area : 40 x 5 mm
Full Color UV Printing / Pad Printing

Ethic

MAX-ET-BC

solid colours with glossy finish, metal chrome finish clip,
white top, chromed tip and two rings



03

18

15

74

09

12

22

04



BRANDING AREA

(1) Barrel Area : 40 x 5 mm
Full Color UV Printing / Pad Printing

Ethic

MAX-ET-CCR

solid colours with glossy finish, metal chrome finish clip,
chromed tip, top and two rings



01

03

18

15

74

09

12

22

04



BRANDING AREA

(1) Barrel Area : 40 x 5 mm
Full Color UV Printing / Pad Printing

Mood

MD1-CM2

solid colours with glossy finish, gold finish metal tip and push-button



**Metal details with
gold mirror finish.**

Mood

MD1-CM3

solid colours with glossy finish, rose gold finish metal tip and push-button



**Rose gold, in line
with the colour trends
of the moment.**

Packaging

FREE Cardboard Packing

Universal single pen case in Natural Color & Full Black
Size : 168 x 43 mm



Colour Palette

Our colour chart is shown below with the Pantone codes closest to those of our Palette. Matches are approximate.

01 white white	70 cream pantone 7499	03 yellow pantone 120	18 orange pantone 1505	15 red pantone 187	74 burgundy pantone 195
60 pink pantone 1905	61 magenta pantone 213	71 light violet pantone 270	25 dark violet pantone violet	37 leather pantone 7571	73 brown pantone 7582
79 lime pantone 381	09 green pantone 348	75 dark green pantone 3435	26 aquamarine pantone 3262	27 octan green pantone 321	64 pastel blue pantone 283
77 cyan pantone 2995	12 light blue pantone 285	22 blue pantone 287	05 grey cool grey 6	04 black cool black 6	



PN07

Arowana Raphael Exclusive Pen

Scale Design Grip
Glossy Black Barrel with Chrome Clip & Tip
Style Ball Pen • Ink Color : Black



PN12

Saturn Raphael Exclusive Pen

Carbon Fiber Design
Glossy Black Barrel with Chrome Clip & Tip
Style Roller & Ball Pen | Ink Color : Black
(B) Ball type | (R) Roller type



Available In Ballpoint & Roller Type





PN17

Venus Raphael Exclusive Pen

Luxury Texture Gold & Silver Design
Full Silver & Full Gold Plated Pen
Style Ball Pen • Ink Color : Black
(S) Silver | (G) Gold

S



G



PN18

Royal Raphael Exclusive Pen

Luxury Texture Silver & Gold Design
Silver Barrel with Gold Plated Clip & Tip
Style Roller Pen • Ink Color : Black





PN15
Blossom Raphael Exclusive Pen

Luxury Gold & Black Design
Glossy Black Barrel with Gold Plated Clip & Tip
Style Roller & Ball Pen • Ink Color : Black
(B) Ball type | (R) Roller type



PN14
Marble Raphael Exclusive Pen

Marble Finish Design
Marble Barrel with Gold Plated Clip & Tip
Style Roller Pen • Ink Color : Black



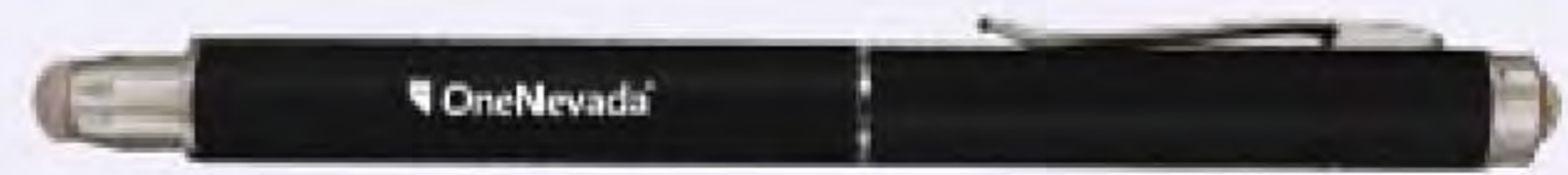

PN21-BK

Amabel Design Metal Pen with Stylus

Luxury Pen with Metallic Fiber Stylus
SWAROVSKI Element attached on Top



W



BK

PN22

Amabel Design Metal Pen

Chrome Luxury Design Pen
SWAROVSKI Element attached on Top



W



BK

PN23

Amabel Design Metal Pen

Luxury Design Pen
SWAROVSKI Element attached on Top



High Quality Pen
Barrel : Glossy Black
Clip & Tip : Chrome

**Grip : Engraved
with Arabic Traditions**



PN52

**Dorniel Metal Pen
with Arabic Traditions Design**

Material : Metal
Size : 140 x 15 mm
Glossy Black Body with Engraving
on Grip, Chrome Clip & Tip.



Packing Box



BRANDING AREA

(1) Top Barrel Area : 40 x 6 mm
Laser Markings / Pad Printing

PN50

Dorniel Design Metal Pen

Material : Metal
 Barrel : Top-Glossy Black & Top-Glossy White
 Grip-Chrome with Texture
 Dorniel Logo Engraved on Middle

- Printing Options :
- Laser Markings
 - Screen Printing
 - Full Color UV Printing (White Pen)



PN51

Dorniel Design Metal Pen

Material : Metal
 Barrel : Glossy Black & Glossy White
 Clip & Tip : Gold Plated
 Dorniel Logo Engraved on Middle

- Printing Options :
- Laser Markings
 - Screen Printing
 - Full Color UV Printing (White Pen)





Jotter

Instantly noticed, Jotter stands as an authentic design icon of the last 60 years. With covetable colours and a distinctive shape, Jotter remains Parker's most popular pen, recognizable down to its signature click.



IM Rollerball

Parker IM's modern design offers timeless finishes successfully combining classic and contemporary styles. The finest grade of lustrous lacquer and chrome, and a highly engineered manufacturing process, ensure the Parker quality known worldwide.



IM Ballpoint

Parker IM, highly professional and reliable. An ideal partner with unlimited potential. With a durable stainless steel nib and finishes that echo the Parker legacy, every detail is refined to deliver a writing experience that is always dependable.

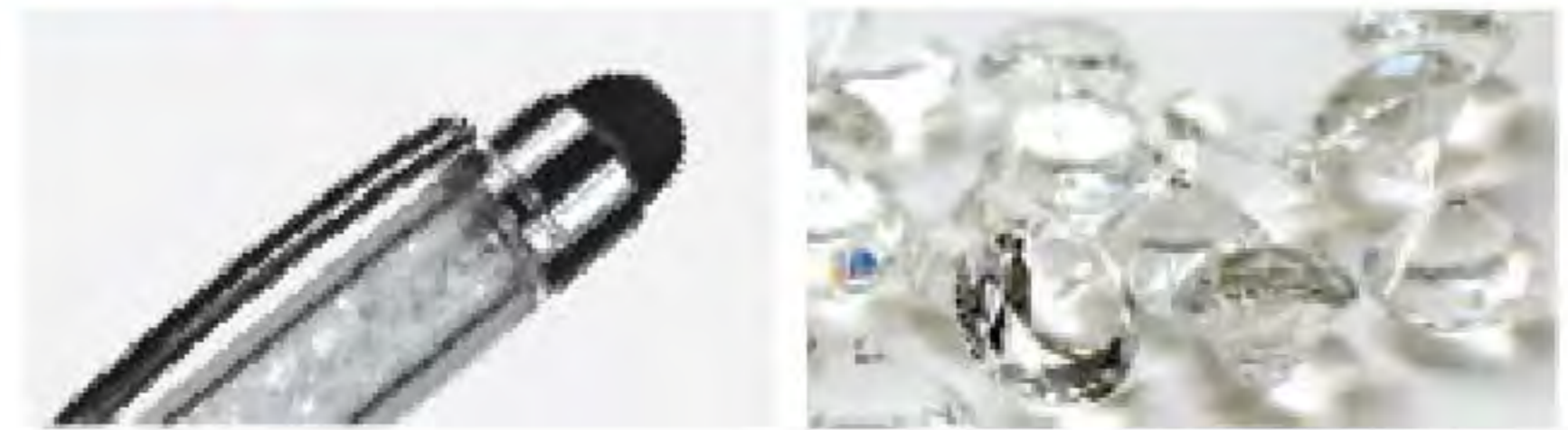

PN19

Crystal Pen with Stylus

Material : Metal with Crystal on Glass
 Metal Pen Crystal Design with Stylus
 Size : 145 x 11 mm

- Printing Options :**
- Full Color UV Printing
 - Screen Printing



Branding on Barrel & Top is available.

PN24

Crystal Pen

Material : Metal with Crystal on Glass
 Metal Pen with Crystal Design
 Size : 145 x 15 mm

- Printing Options :**
- Full Color UV Printing
 - Screen Printing
 - Full color printing with epoxy (top)





PN43
Rubberized Black Metal Pen with Stylus

Material : Metal
 Black rubberized barrel with black clip & tip
 Coloured stylus touch screen.

Printing Options :
 • Laser Marking



PN44
White Metal Pen with Stylus

Material : Metal
 Glossy white barrel with chrome clip & tip
 Coloured stylus touch screen.

Printing Options :
 • Laser Marking
 • Full Color UV Printing



Info :
 After Laser Markings, Finishing matches the colour of your stylus rubber tip.

RUBBERIZED BARREL DESIGN



BK GR OR BL GY DBL R

PN42

Rubberized Metal Pen with Stylus

Material : Metal & Plastic
Rubberized Texture Barrel | Dimensions : 140 x 12 mm

Printing Options :
• Laser Markings (Shiny Silver Effect)



BL GR R GY BK

PN45

Aluminum Pen with Stylus

Material : Aluminum
Coloured Barrel with stylus,
push-button mechanism.
Size : 137 x 10 mm

Printing Options :
• Laser Markings
• Screen Printing



SLIM PEN

PN20

Slim Metal Pen with Stylus

Material : Metal
Slim Pen with Stylus on top.
Size : 135 x 8 mm

Printing Options :
• Laser Marking
• Full Color UV Printing



SL

DG

BK

W

R

BL



SL

R

BL

BK

PN27

2 In 1 : Rubberized Metal Pen with Stylus

Material : Metal
Rubberized Texture Promotional Pen

Printing Options :
• Laser Engraving (Shiny Silver)



PN56
Black Rubberized Promotional Metal Pen

Material : Metal
 Rubberized Texture Barrel
 Size : 140 x 13 mm

Printing Options :
 • Laser Markings (Shiny Silver)



PN57
Silver & Black Rubberized Metal Pen

Material : Metal
 Rubberized Area for Logo
 Size : 145 x 12 mm

Printing Options :
 • Laser Markings (Shiny Silver)



PN35
3 In 1: Metal Pen with Stylus & Phone Holder

Material : Metal & Plastic
 Coloured Metal Barrel with Black Clip & Tip
 Size : 145 x 17 mm

Printing Options :
 • Laser Markings (Barrel)
 • Screen Printing (Clip)



3 in 1
Multi-function Metal Pen

Pen + Stylus + Mob. Holder





BK



W

073

High Quality Metal Pen

Printing Options : Full Color UV Printing, Screen Printing, Laser Markings



PN28

Matt Silver Metal Pen

Printing Options : Full Color UV Printing, Screen Printing, Laser Markings

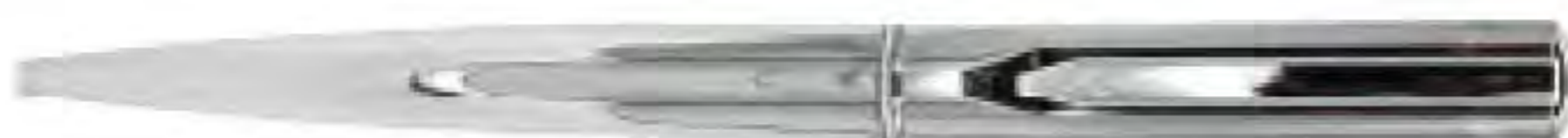

PN30

Full Chrome Metal Pen

Printing Options : Laser Marking



PN29

Black & Chrome Metal Pen

Printing Options : Laser Marking (Shiny Silver)



PN08-B

High Quality Metal Pen

Material : Metal
Maroon Barrel with Chrome Clip & Tip

Printing Options :
• Screen Printing
• Laser Engraving





072

Promotional Pen

Material : Metal
 Pen with Rubber Grip
 Round Logo Area
 Size : 135 x 15 mm
 Printing Options :
 • Full Color Printing with Epoxy



PN40

Stylish Roller Pen

Triangular Shape Pen with Glossy finish & chrome parts
 Material : Metal | Size : 140 x 13 mm

Printing Options : Full Color UV Printing (White) or Laser Marking



Equipped with Schelder Ref III



MADE IN GERMANY



PN32

High Quality Metal Pen

Material : Metal
 Coloured Barrel with Chrome Clip & Tip
 Printing Options :
 • Laser Marking
 • Screen Printing



PN04

High Quality Metal Pen

Solid Color Barrel with Chrome Clip & Tip

Printing Options:

- Full Color UV Printing (White Pen)
- Laser Marking - Shiny Silver Effect (Black Pen)



PN03

High Quality Metal Pen

Matte Black / Glossy White with Chrome Clip & Tip

Printing Options:

PN03-BK

- Screen Printing
- Laser Markings (Shiny Silver)

PN03-W

- Full Color UV Printing
- Screen Printing

PN09

High Quality Metal Pen with Chinese Design Grip

Metal Roller Pen in Bronze Barrel with Chinese Design. Glossy Black clip with gold clip & tip. Size : 135 x 15 mm

Printing Options:

- Laser Marking
- Screen Printing



PN31

Matte Metal Pen

Printing Options:

PN31-MS

- Full Color UV Printing & Screen Printing

PN31-GY

- Laser Marking
- Screen Printing



MS

GY





PN10

Black & Gold Metal Pen

Gold Plated Tip & Clip with Silver Trims
Material : Metal | Size : 140 x 17 mm

- Printing Options :
- Laser Marking
 - Screen Printing



PN37

Rubberized Metal Pen with Gold Plated Clip

Rubberized Texture Barrel
Material : Metal | Size : 140 x 14 mm

- Printing Options :
- Laser Marking (Shiny Gold Effect)



BR



W

PN26

3 In 1: Metal Pen with Stylus & Light

Material : Metal
Pen with Stylus & LED light
Size : 130 x 15 mm

- Printing Options :
- Full Color UV Printing or Laser Markings



High Quality Plastic Pen
Original Plastic (Not Recycled)
Chrome Tip



063

Branded Plastic Pen

Material : Original Plastic
1200 Meters Ink - Made in Germany

- Printing Options :
- Full Color UV Printing
 - Screen Printing



062

Branded Plastic Pen

Material : Original Plastic
1200 Meters Ink - Made in Germany

- Printing Options :
- Screen Printing
 - Full Color UV Printing





060

Prism Design Plastic Pen

Material : Plastic
High Quality Prism Pen

Printing Options :
• Full Color UV Printing
• Screen Printing

⊗ Prism Barrel



R

GR

BL

W

BK



061

Twisted Design Plastic Pen

Material : Plastic
High Quality Twisted Pen

Printing Options :
• Full Color UV Printing
• Screen Printing

⊙ Twisted Barrel



DBL

SBL

GR

R

OR

W

BK



PN41

Pen with Light Underlay & Stylus Touchscreen

Illuminate your brand with our Light Up Pen. Press the stylus to illuminate barrel imprint. Rubber finish grip and touch tip. Features a twist tip to reveal ballpoint. Includes 3 AG3 batteries. Material : Plastic & Metal

Printing Options :
• Laser Engraving (Light Up Logo)



BK BL R

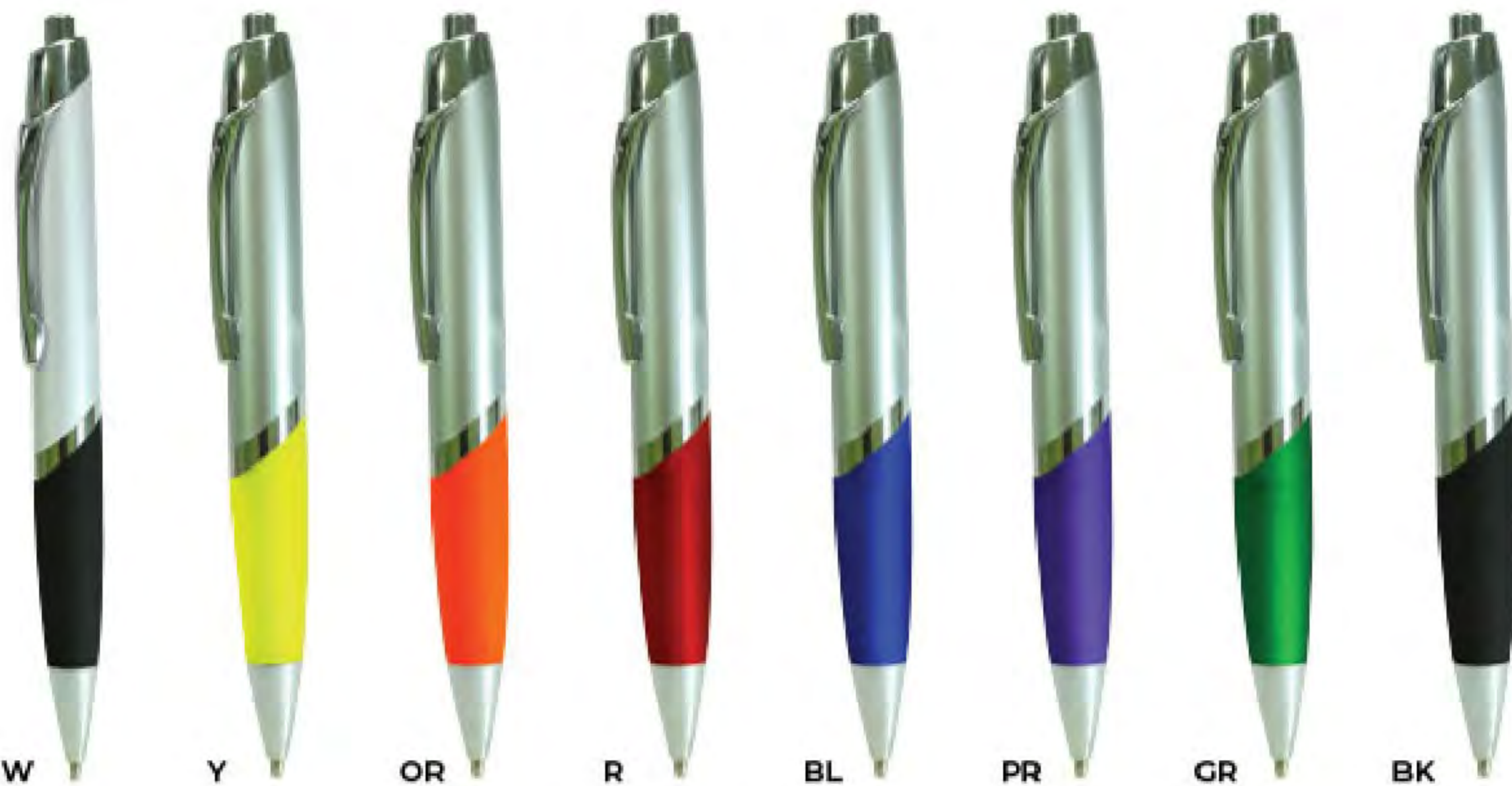

W Y OR R BL PR GR BK

098

Promotional Plastic Pen

Material : Plastic
Matte Texture Coloured Grip with Chrome Clip

Printing Options :
• Full Color UV Printing

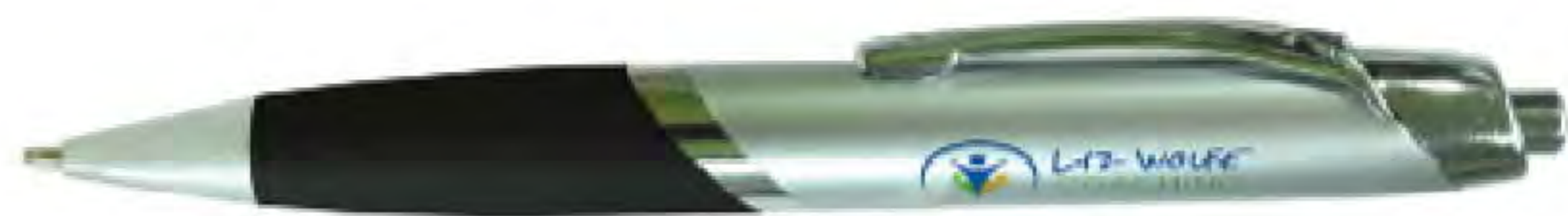



Matte Textured Plastic Pen with Plastic Packing Box



BK R W BL

066

Promotional Plastic Pen

Material : Plastic
Matte Texture Plastic Pen with Silver Clip & Tip.

Printing Options :

- Full Color UV Printing & Screen Printing



BK R GR BL OR

097

Promotional Plastic Pen

Material : Plastic
High Quality Plastic Pen with German Refill

Printing Options :

- Full Color UV Printing & Screen Printing

Round Logo

An Ideal Pen to Promote your Circular Logos in Full Color Printing with Epoxy.



BL R GR BK SL

101

Big Logo Plastic Pen

Material : Plastic
Coloured Barrel with Round Area on Clip

- Printing Options :
- Full Color printing with Epoxy
 - Pad Printing



BL R GR BK W

090

Two Side Logo Plastic Pen

Material : Plastic
Coloured Transparent pen with Round Area for Logo
2 Side Printing.

- Printing Options :
- Full Color printing with Epoxy
 - Pad Printing



092-BL

Big Logo Plastic Pen

Material : Plastic
Pen with 25mm round area for Logo.

Printing Options :
• Full Color printing with Epoxy

↓
25 mm
↑



079-BL

Promotional Plastic Pen

Material : Plastic
Blue Coloured Barrel & Grip with Chrome Clip & Tip

Printing Options :
• Screen Printing
• Full color UV Printing

Made from

Wheat Straw

Material

50%
MADE FROM
ORGANIC
WHEAT STRAW
MATERIAL

50%
PLASTIC
MATERIAL



W BK BL GR

074

Wheat Straw Pen

Ballpoint Pen with body made of of wheat straw and PP.
Great barrel texture with stylish & large clip design
suitable for single or multi-color printing

Printing Options : Full Color UV Printing or Screen Printing

ECO Friendly Pens



070

Wheat Straw Pen with Stylus

Ballpoint Pen with body made of of wheat straw and PP.
Black clip & tip, twist mechanism, with stylus on top.

Printing Options : Full Color UV Printing or Screen Printing





071

Wheat Straw & Cork Promotional Pen

This ballpoint pen is made out of wheat straw clip, tip & push-button, and a cork material on barrel. Push-button mechanism. With its large clip its a great way to promote your brand in multi-color printing.

Printing Options:

- Screen Printing
- Full Color UV Printing



ENVIRONMENT FRIENDLY



50%
Less Plastic

078

Coffee Promotional Pen

Ballpoint Pen with body made from coffee material. Push-button mechanism.

Printing Options:

- Screen Printing
- Full Color UV Printing





BK S R BL

067

Paper Pen

Pen made out of recycled paper with a combination of plastic tip and a stylish metal clip.

- Printing Options :
- Full Color UV Printing
 - Screen Printing



069-S

Bamboo Pen

A combination of Nature friendly and Style in a pen. Barrel is made from bamboo with a silver clip, tip and push-button.

- Printing Options :
- Screen Printing
 - Laser Engraving



WWS GWS

068

Bamboo with Wheat Straw Pen

Ballpoint Pen with body made of bamboo and a wheat straw clip & tip. Push-button mechanism.

- Printing Options :
- Screen Printing or Laser Engraving

GFK-04

Promotional Pencil with Eraser

Wooden pencil with round body in natural finish and rubber eraser in white colour.

- Printing Options :
- Full Color UV Printing
 - Screen Printing



GFK-05

Coloured pencil, Sharpener, Eraser & Ruler on wooden box.

Dimensions : 20.8 x 4 x 3 cm

- Printing Options :
- Full Colour UV Printing
 - Screen Printing





LPB-01

Leather Pen Packing Box

High Quality & Luxurious Design
Leather Black Cover with white stitches
and soft white velvet interior.
Dimensions : 18 x 6.5 x 4.5 cm



LPB-02

Leather Pen Packing Box

High Quality & Luxurious Design
Leather Black Cover with white stitches
and soft white velvet interior.
Dimensions : 19.5 x 9.5 x 4.5 cm



WPB-01

Wooden Pen Packing Box

Glossy Black Design
High Quality Hard Wood Material
with soft velvet interior.
Dimensions : 20 x 8 x 4.5 cm



PPB-05

Black Cardboard Pen Box

Matte Black Pen Box
Cardboard Material
Dimensions : 17.5 x 4.5 x 2.5 cm



PPB-03

Cardboard Packing Box

Great Packing Design
Card board with Felt Material
Dimensions : 18 x 6.5 x 2.5 cm



PPB-02

Cardboard Packing Box

A paper material box with
velvet inside.
Dimensions : 18.5 x 6 x 2.5 cm



279

Clear Plastic Pen Box

Transparent Plastic Box to fully show your Pen
Dimensions : 15.8 x 2.3 x 2.3 cm



297

Clear Plastic Box

Transparent Cover, Solid Black Base Velvet with Center Clip
Dimensions : 16.2 x 3.5 x 2 cm



95

Black Velvet Pen Pouch

A sleek velvet pouch with slide opening that holds 1 pen.
Dimensions : 15.9 x 3.5 cm



PNC

Felt Material Pen Packing

Made of felt in Vivid colours.
Size : 4.5 x 16.5 cm

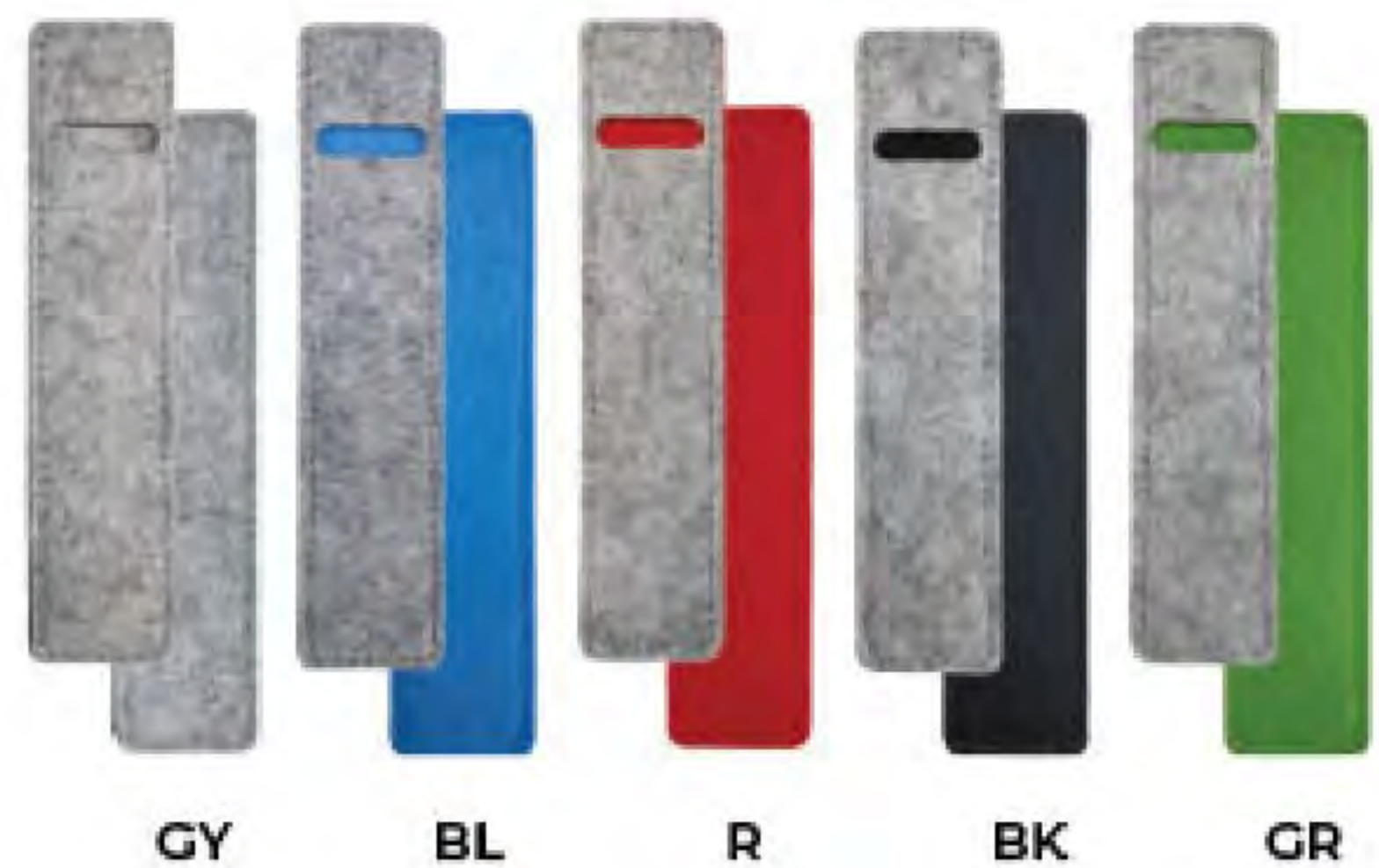

GY

BL

R

BK

GR

Customized Pen Case

Print your own Design with Logo
The Pen case is made of FSC, 300g paper
Dimensions : 16.8 x 4.4 cm

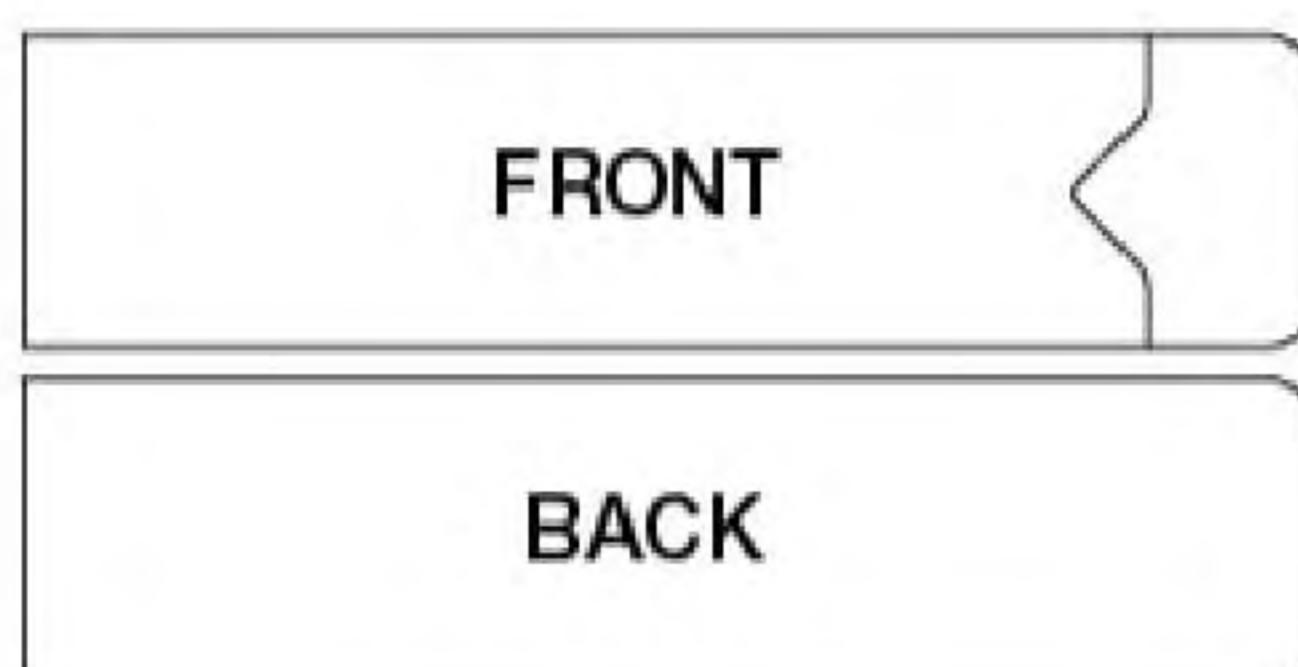

FRONT

BACK





GENERAL

PROMOTIONAL

PRODUCTS

Your reliable source for a wide range of promotional gifts whether for corporate or just a simple occasion, we have the right gifts for your needs.

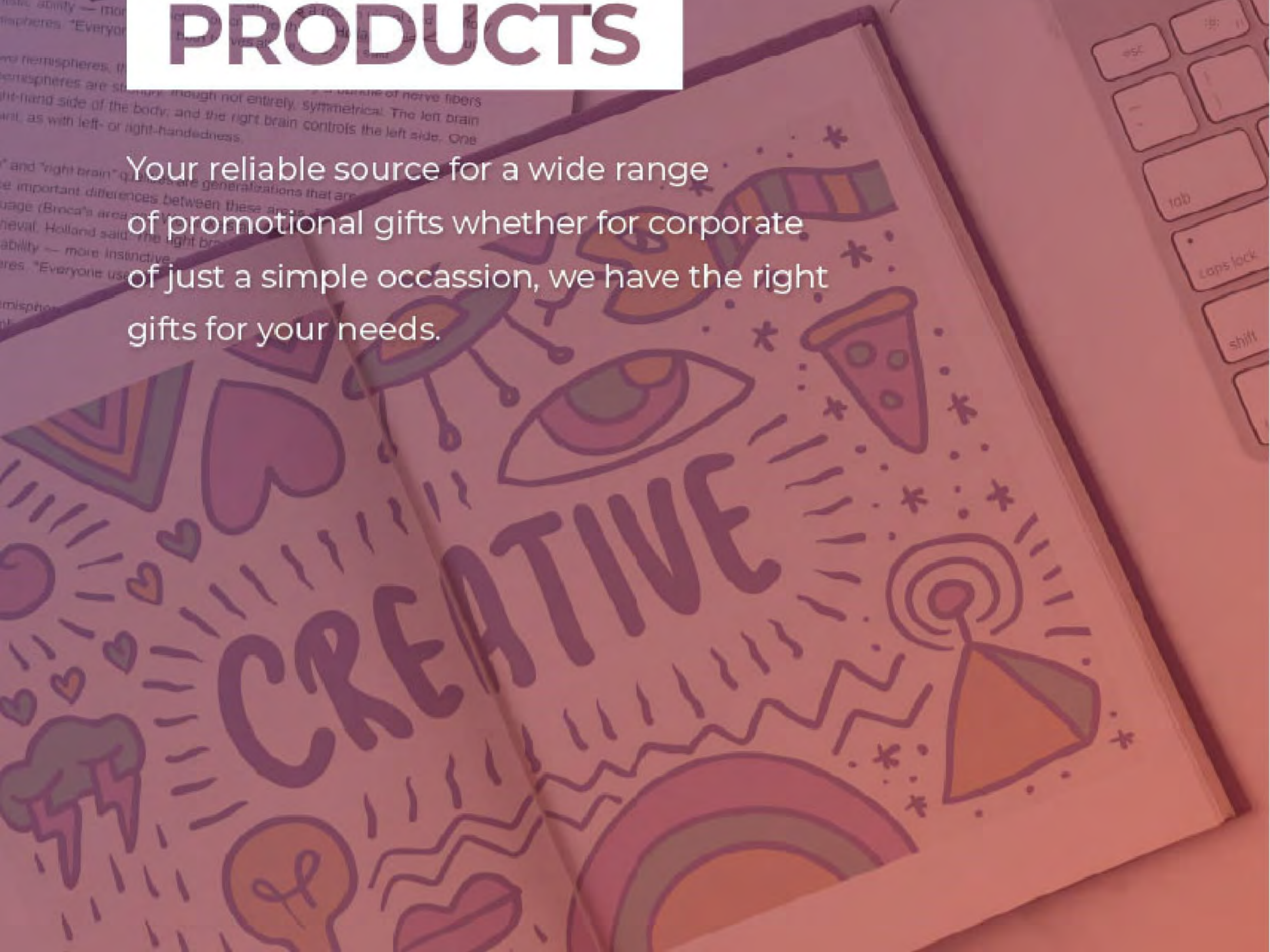



PU Notebook

for Single or Multi-color Printing

MB-05

**A5 Size PU Leather Notebook
with Calendar, Pocket & Pen Holder**

Cover Material : PU
Size : A5 (140 x 210 x 20 mm)

- Printing Options:
- Screen Printing
 - Full Color UV Printing
 - Debossing





MB-06

PU Leather Notebook

Cover Material : PU
Size : (A6)

- Printing Options :
- Screen Printing
 - Full Color UV Printing
 - Debossing



USB-MB

A5 PU Notebook with USB Flash Drive

Cover Material : PU
Size : A5 (140 x 210 x 20 mm)
Available Capacity : 4, 8, 16 or 32 GB.

- Printing Options :
- Full Color UV Printing
 - Screen Printing
 - Debossing

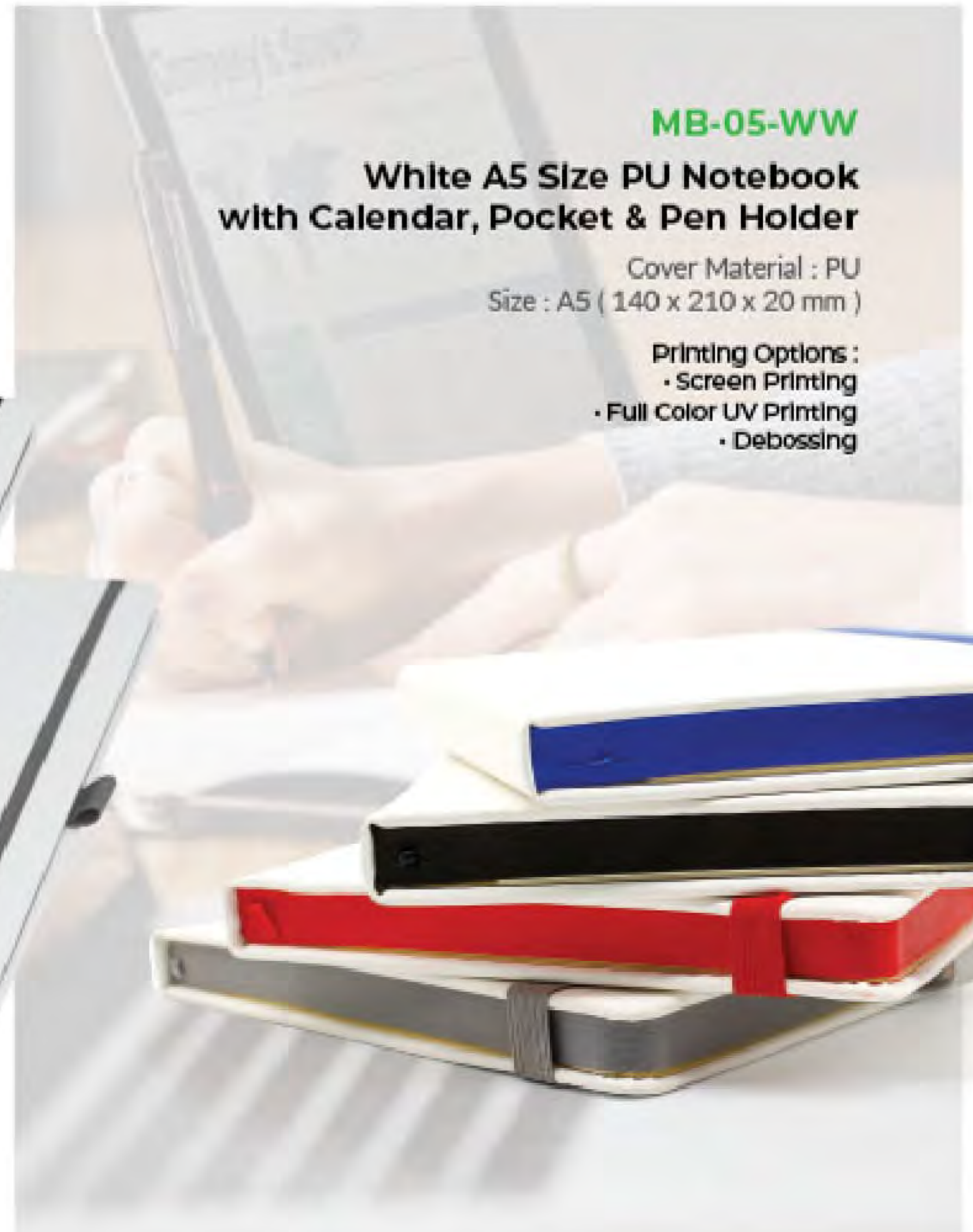

MB-05-WW

White A5 Size PU Notebook with Calendar, Pocket & Pen Holder

Cover Material : PU
Size : A5 (140 x 210 x 20 mm)

- Printing Options :
- Screen Printing
 - Full Color UV Printing
 - Debossing



DORNIEL DESIGNS

MB-D

Dorniel Design A5 Size Notebook with Calendar, Pocket & Pen Holder

Cover Material : Fabric + PU
Size : A5 (140 x 210 x 20 mm)

- Printing Options :
- Screen Printing
 - Full Color UV Printing
 - Debossing



MB-05-CC

A5 Size PU Leather Notebook

PU leather notepad in a solid color leather cover. Covers especially designed for debossing. Color changes on PU leather cover after debossing. Size : A5 (155 x 210 x 14 mm)

Printing Options :

- Debossing
- Screen Printing

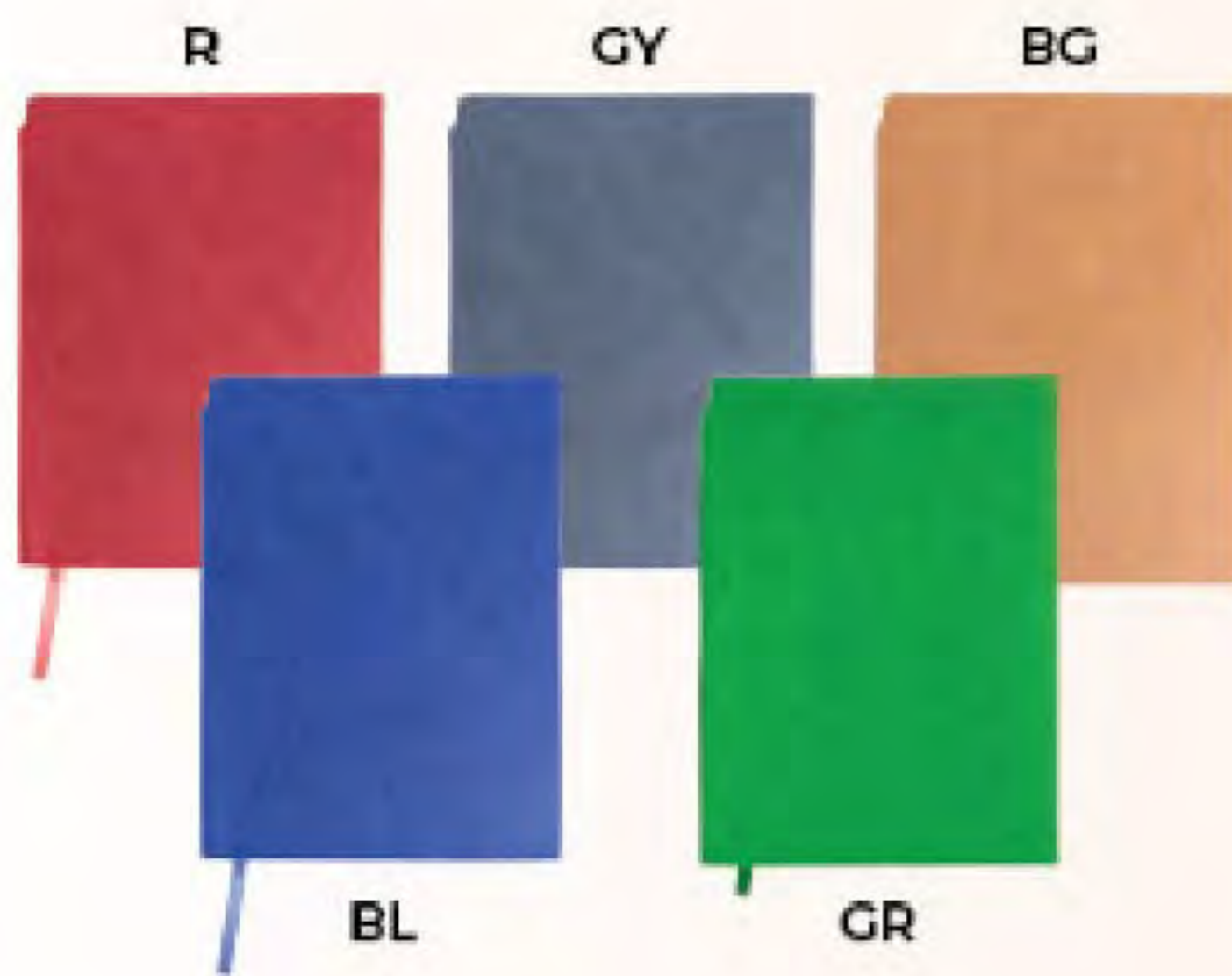

MB-05-BKK

Black A5 Size Notebook with Pen & Mobile Holder

Cover Material : PU Leather
Size : A5 (140 x 210 x 20 mm)

Printing Options :

- Screen Printing
- Full Color UV Printing
- Debossing

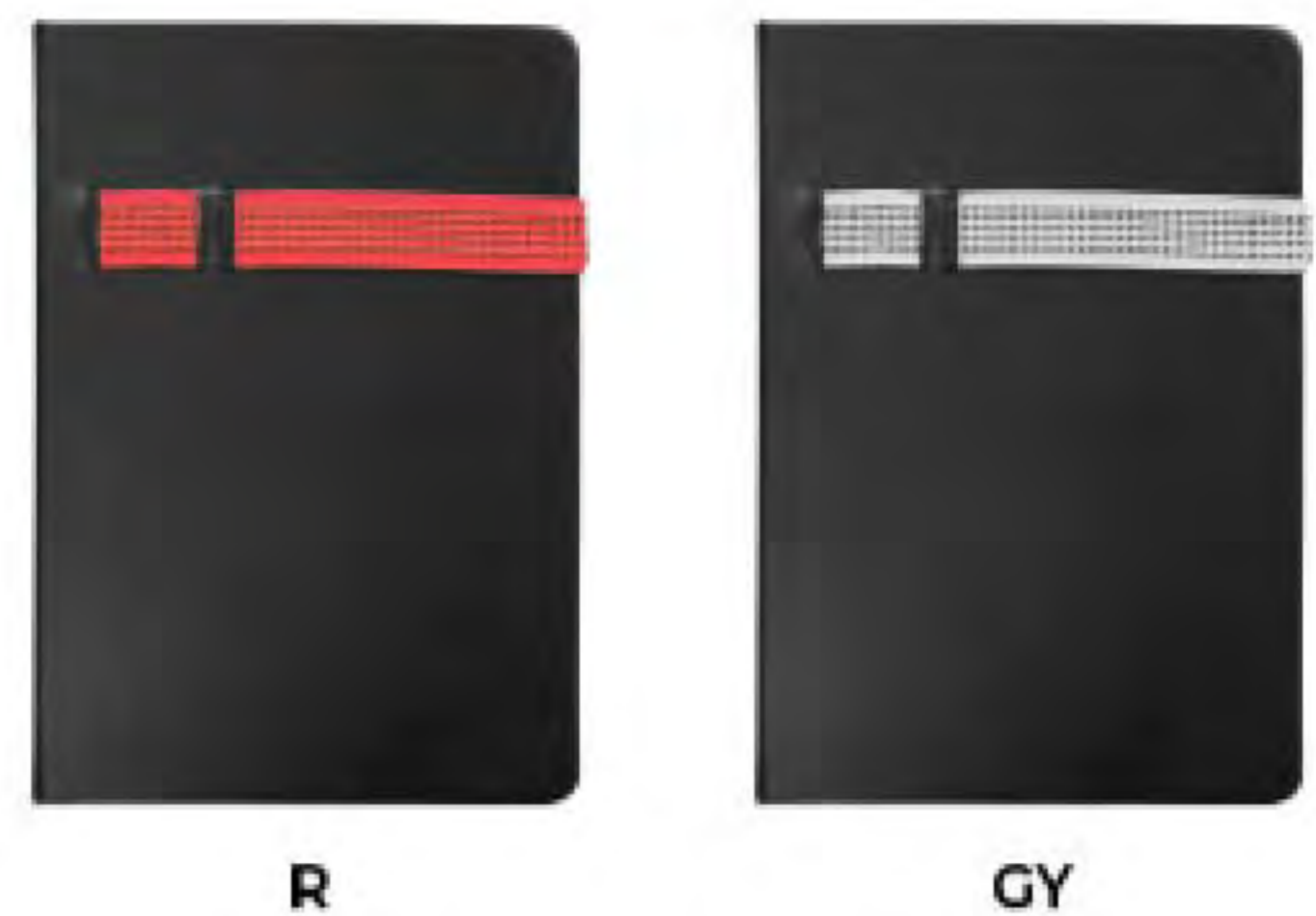

BL



MB-05-LP

**Hard Cover A5 Size Notebook
with Pen Holder & Ribbon Bookmark**

Size : A5 (140 x 210 x 20 mm)

- Printing Options :
- Full Color UV Printing
 - Screen Printing



RNP-11

**Wood Design Notebook
with Sticky Notes & Pen**

Wood like notebook cover with recycled cardboard pen.
Eco design with soft touch covers & elastic closure.
With built-in ball pen holder, 70 sheet notepad with
striped layout, 25 large and 125 mini sticky notes.
Size : 105 x 155 x 23 mm

- Printing Options :
- Full Color UV Printing
 - Screen Printing





MB-05-C

A5 Size Cork Cover Notebook with Pocket & Pen Holder

Eco friendly, natural cork texture hard covers notebook. elastic band and fabric bookmark in sober black color.
Cover Material : Cork | Size : A5 (140 x 210 x 20 mm)

- Printing Options :
- Full Color UV Printing
 - Screen Printing



RNP-05

Eco Friendly Material A5 Size Notebook with Pen holder.

Cover Material : Hardboard
Size : A5 (140 x 210 x 20 mm)

- Printing Options :
- Full Color UV Printing
 - Screen Printing

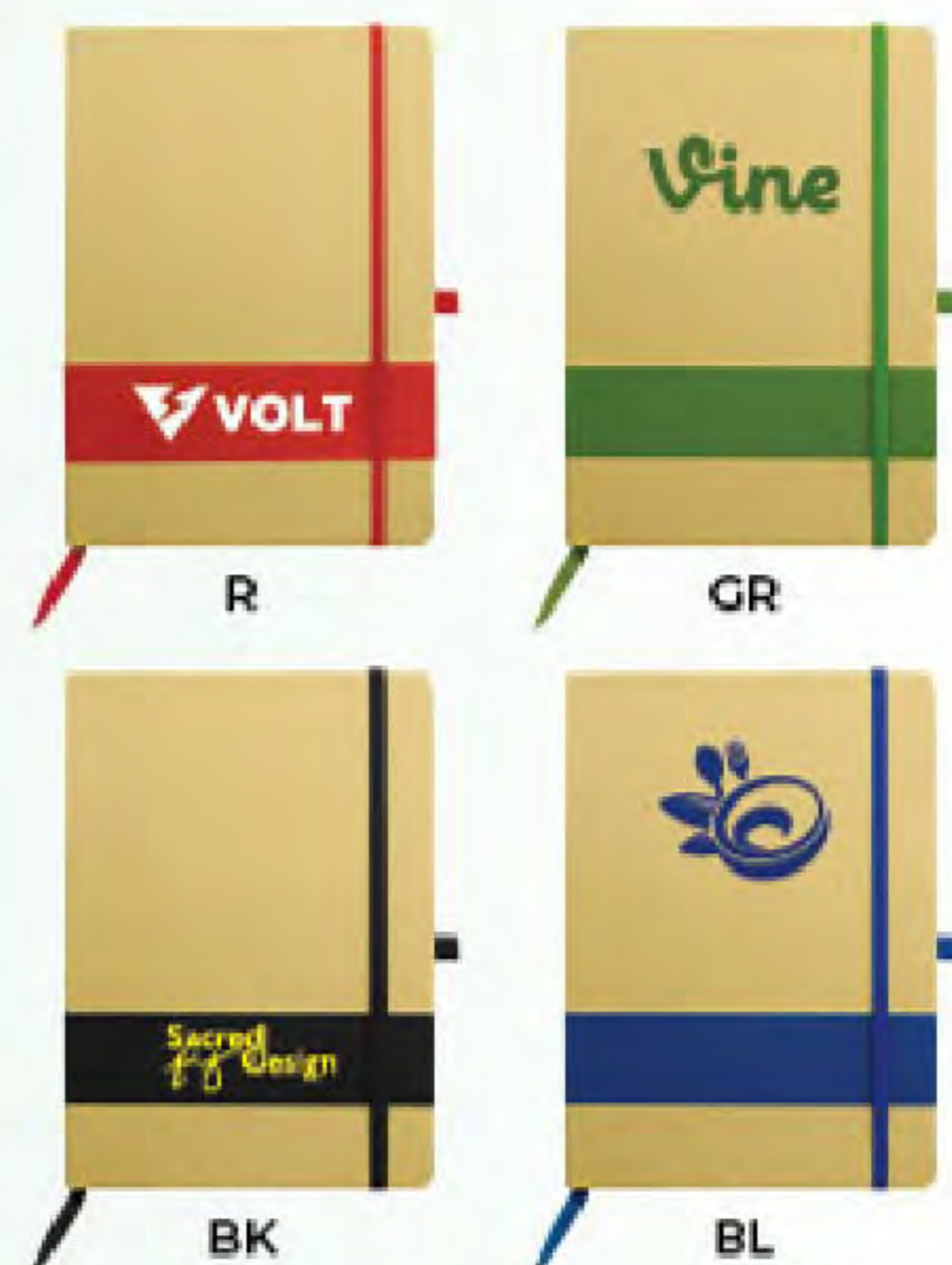



RNP-04

Recycled Notepad with Pen

Ring notepad with soft-touch covers in resistant bicolor recycled cardboard. With elastic fastening on the cover and recycled pen in matching color.
Cover Material : Cardboard | Size : 90 x 140 mm

- Printing Options :
- Screen Printing
 - Full Color UV Printing



R



GR



BK



BL



RNP-01

Recycled Notebook with Stylus Pen

Ring notebook with soft-touch covers in resistant bicolor recycled cardboard, elastic fastening on the cover and ball pen in matching color recycled cardboard.
Cover Material : Cardboard | Size : 160 x 210 mm

- Printing Options :
- Screen Printing
 - Full Color UV Printing



R



GR



BK



BL

RNP-06

Recycled Notebook with Sticky Note & Cardboard Pen

Spiral notepad with recycled cardboard covers. Bold cover design, with a die-cut showing the colors of the sticky notes inside. Notepad sheets in a striped format with a cutted area for a eco friendly promotional pen made from cardboard.

- Size : 14.5 x 17.5 cm
- Printing Options :**
- Screen Printing
 - Full Color UV Printing



RNP-08

Recycled Pad Holder with Sticky Note & Pen

Eco friendly material notepad with a flap area showing a different color of sticky notes, also includes a pen with a recycled paper barrel.

- Printing Options :**
- Full Color UV Printing
 - Screen Printing



RNP-03

Recycled Pad Holder with Pencil

Made with Recycled Paper.
Size : 11 x 10 x 3 cm

- Printing Options :**
- Full Color UV Printing
 - Screen Printing



RNP-02

Recycled Notepad with Sticky Notes & Pen

Cover Material : Cardboard Notepad , Sticky Notes & Pen covered with cardboard flap.
Size : 15 x 9 cm

Printing Options :
• Screen Printing



R GR BK BL



RNP-10

Recycled Notepad with Sticky Notes

Spiral notepad in cardboard covers with smiley cut out, showing a first layer with a sticky 2 types of note & below is the second layer with the notepad is striped format.

Printing Options :
• Screen Printing
• Full Color UV Printing



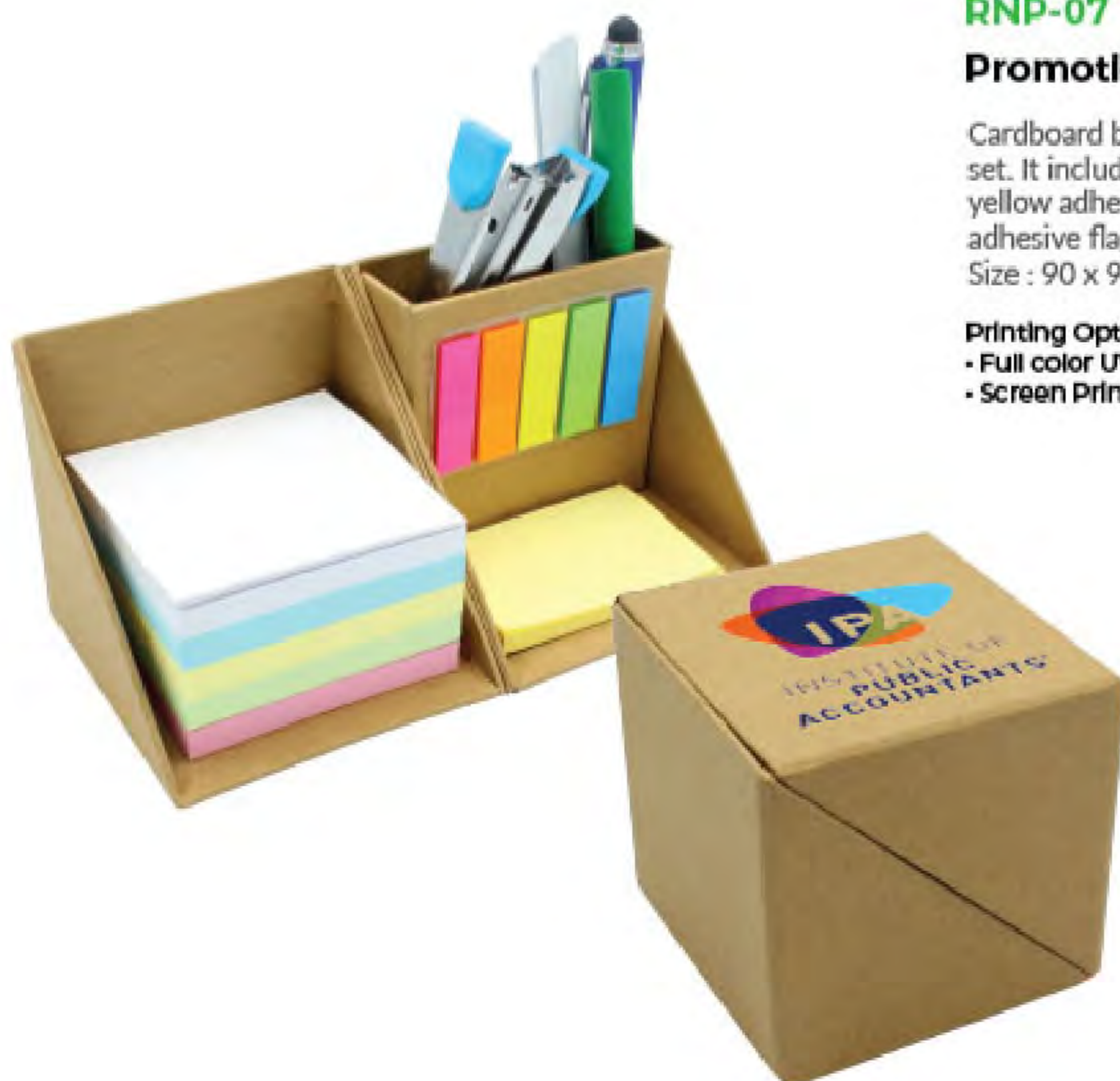

RNP-07

Promotional ECO paper cube box

Cardboard box which flips open to reveal a handy sticky note set. It includes a block of multi coloured note paper, a pad of yellow adhesive notes, five pads of different coloured adhesive flags and a pen / accessories holder.
Size : 90 x 90 x 90 mm

- Printing Options :
- Full color UV Printing
 - Screen Printing

RNP-09

Promotional Writing Set

Eco friendly tri-fold writing set with strap closure. Contains 50 sheet notepad in the center, pocket and sticky notes on the right panel, Eco friendly pen, ruler, 2pcs. natural coloured pencils, sharpener and eraser on the left panel.
Folded Size : 150 x 210 x 25 mm

- Printing Options :
- Full color UV Printing
 - Screen Printing





MB-02

Pad & Sticky Note with Leather Case

Leather box contains different types of sticky note and pad in different shapes and color.

Cover Material : Leather

Printing Options : Screen Printing, Emboss or Deboss



MB-01

PVC Hard Cover Notepad with Pen

Notepad with plastic pen, suitable for full color printing.
Size : 11 x 10 x 3 cm

Printing Options : Full Color UV Printing



MB-03

Leather Portfolio with Zipper & Calculator

Cover Material : Leather
Size : 25.5 x 33.5 cm

Printing Options :
• Screen Printing

Paper Size
19.5 x 28.5
cm

- Attached Calculator
- Zippered Pockets
- Pen & Card Holder





MB-07-BK
(PU Leather)

MB-07-GY
(Grey Fabric with PU)

Paper Size
21 x 29
cm

Product Size :
230 x 300 x 20 mm
packed in a black box.

MB-07

**Dorniel Designs
Portfolio Folders**

Cover Material : PU leather & Black fabric with PU
Magnetic Clasp with metal for laser markings.
ID & Card Pockets, Mesh pocket for cables,
Mobile Phone Strap & Holder.
Smart & Casual : Organize your documents,
Gadgets & accessories in one folder.

Printing Options :

- Laser Markings (Magnetic Clasp)
- Screen Printing (Cover Area)

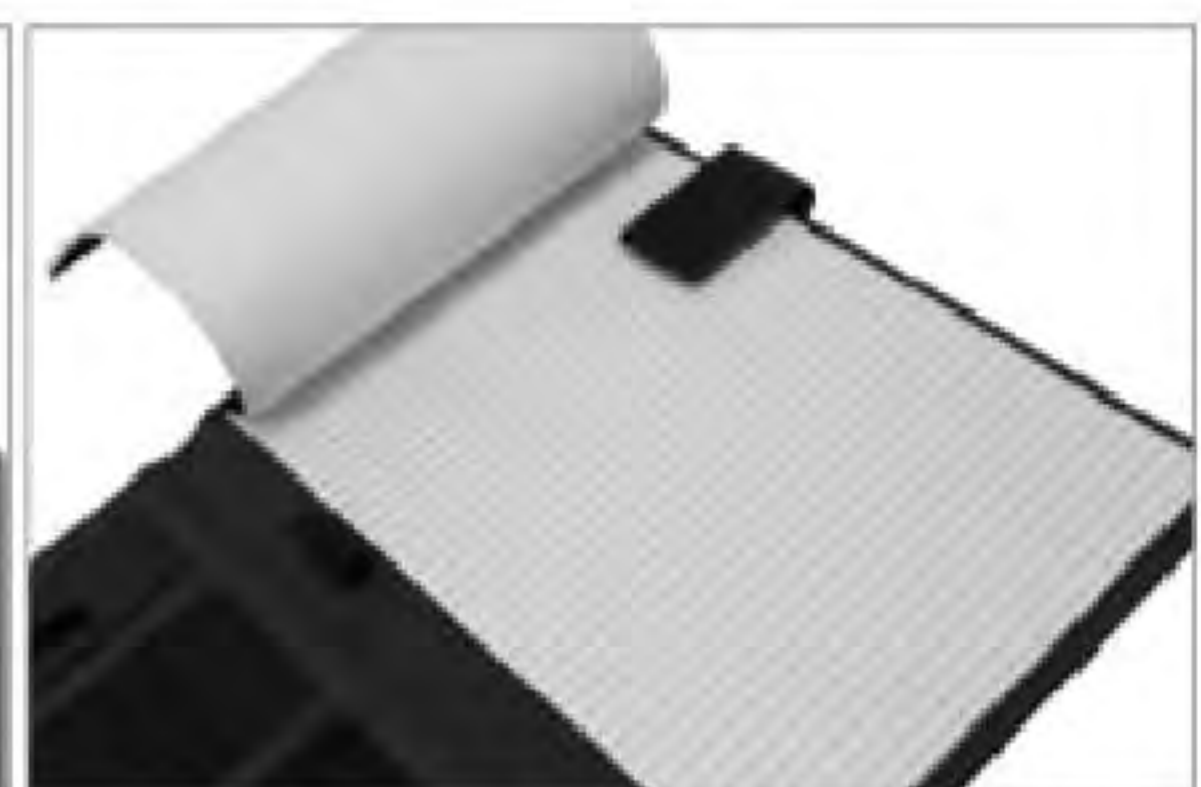



Ideal Notebook for Corporate or Personal use.

MB-08

Portfolio Notebook with Multi-purpose holders

Cover Material : PU leather & Black fabric
 Magnetic Clasp with metal for laser markings.
 Mobile phone pocket in front & inside.
 Mobile holder & Pen holder.
 A5 Size high quality notebook

Printing Options :

- Laser Markings (Magnetic Clasp)
- Screen Printing (Cover Area)



MB-08-PU
(PU leather)



MB-08-BF
(Black Fabric)





22-BK

Round Shaped Metal Keychain for 1 side printing.

Round Keychain with Black Plate
Product Size : 45 x 40 mm (Base)
Packing Box Size : 110 x 50 mm

Printing Options :
• Laser Marking



22

Round Shaped Metal Keychain for 1 side printing.

Round Keychain with a shiny silver finish.
Product Size : 45 x 40 mm (Base)
Packing Box Size : 110 x 50 mm

Printing Options :
• Full Color with Epoxy
• Laser Markings



25-BK

Rectangular Oval Metal Keychain for 1 side printing.

Rectangular Oval Keychain with Black Plate
Product Size : 55 x 25 mm (Base)
Packing Box Size : 110 x 50 mm

Printing Options :
• Laser Marking



25

Rectangular Oval Metal Keychain for 1 side printing.

Rectangular Oval with a Shiny silver finish.
Product Size : 55 x 25 mm (Base)
Packing Box Size : 110 x 50 mm

Printing Options :
• Full Color with Epoxy
• Laser Markings

23-BK

Rectangular Shaped Metal Keychain for 1 side printing.

Rectangle Keychain with Black Plate
 Product Size : 50 x 32 mm (Base)
 Packing Box Size : 110 x 50 mm

Printing Options :
 • Laser Marking



23

Rectangular Shaped Metal Keychain for 1 side printing.

Rectangle Keychain with a Shiny silver finish.
 Product Size : 50 x 32 mm (Base)
 Packing Box Size : 110 x 50 mm

Printing Options :
 • Full Color with Epoxy



24

Square Shaped Metal Keychain for 1 side printing.

Square Keychain with a shiny silver finish.
 Product Size : 30 x 38 mm (Base)
 Packing Box Size : 110 x 50 mm

Printing Options :
 • Full Color with Epoxy



26

Oval Shaped Metal Keychain for 1 side printing.

Oval Keychain with a shiny silver finish.
 Product Size : 55 x 27 mm (Base)
 Packing Box Size : 110 x 50 mm

Printing Options :
 • Full Color with Epoxy





20

Oval Shaped Metal Keychain for 1 side printing.

Oval keychain with a shiny silver finish.
Product Size : 50 x 28 mm (Base)
Packing Box Size : 110 x 50 mm

Printing Options :
• Full Color with Epoxy



27

Round Shaped Metal Keychain for 2 side printing.

Round keychain with a shiny silver finish.
Product Size : 40 x 30 mm (Base)
Packing Box Size : 110 x 50 mm

Printing Options :
• Full Color with Epoxy (2 sides)



2 Side Printing

28

Oval Shaped Metal Keychain for 2 side printing.

Oval keychain with a shiny silver finish.
Product Size : 44 x 24 mm (Base)
Packing Box Size : 110 x 50 mm

Printing Options :
• Full Color with Epoxy (2 sides)



2 Side Printing

29

Rectangular Shaped Metal Keychain for 2 side printing.

Rectangle keychain with a shiny silver finish.
Product Size : 53 x 28 mm (Base)
Packing Box Size : 110 x 50 mm

Printing Options :
• Full Color with Epoxy (2 sides)

KH-1

**Rectangular Metal Keychain
with Leather Strap**

Metal & Leather
Product Size : 20 x 90 mm (Base)
Packing Box Size : 110 x 50 mm

Printing Options :
• Laser Marking



KH-2

Metal with Strap Keychain

Square Steel Part with Leather Strap
Product Size : 55 x 20 mm (Base)
Packing Box Size : 110 x 50 mm

Printing Options :
• Laser Marking



KH-3

Metal Keychain

Long Vertical Design Metal Keychain
Product Size : 55 x 15 mm (Base)
Packing Box Size : 110 x 50 mm

Printing Options :
• Laser Marking



93372

Promotional Keychains

Stylish & Trendy Design.
Material : Metal and ABS
Product Size : 29 x 40 x 4 mm

Printing Options :
• Laser Markings
• Screen Printing





Metal Keychain with Colored Strap

Rectangle Metal with Strap
Product Size : 60 x 28 mm (Base)
Packing Box Size : 110 x 50 mm

Printing Options :
• Laser Marking
• Screen Printing



35

Promotional Keychains with Domed Area

Stylish & Trendy Design.
Material : Metal
Product Size : 27 x 61 x 5 mm

Printing Options :
• Full color with epoxy



007E

Round Shaped Acrylic Keychains

Clear Acrylic photo keychain
Size : 45 mm dia.

Printing Options :
• Full Color Digital Printing

AF-001**Promotional
Flash Light**

Aluminum Light weight
Small & Portable Design
Size : 82 x 24 mm
Battery : AAA (not included)

Printing Options :
• Laser Markings

**034-BK****Multi-functional knife**

Multi-function knife is a range of portable, versatile hand tools that combines several individual functions in a single unit.

Printing Options :
• Full Color Printing with Epoxy
• Screen Printing

**94155****Multifunction pocket knife**

Multifunction pocket knife.
Stainless steel and plastic.
With 13 functions
Material : Stainless Steel
Size : 90 x 20 x 17 mm

Printing Options :
• Laser Markings
• Screen Printing





LTR-W

Promotional Lighter

Portable device used to create a flame, and to ignite a variety of combustible materials, such as cigars, candles or more.

- Printing Options:**
- Full Color UV Printing



SG

Promotional Sunglasses

Stylish & Trendy Design.
White Glasses is great for full color printing

- Printing Options:**
- Full Color UV Printing (White)
 - Screen Printing (Black)



JU-WM

Promotional Wireless Mouse

A customisable standard 2.4G wireless mouse that works within suitable range. This wireless mouse requires AAA batteries. The wireless mouse is available in black and white and is packaged in a clear transparent box with ABS casing.

Product Size : 57 x 113 x 20 mm
Packing Box Size: 62 x 120 x 30 mm

- Printing Options:**
- Full Color UV Printing
 - Screen Printing



266-A

Promotional Mouse Pad

Thickness : 5 mm
Product Size : 20 x 23 cm



266-B

Promotional Mouse Pad

Thickness : 3 mm
Product Size : 20 x 23 cm



263

Round Mouse Pad

Thickness : 3 mm
Product Size : 20 cm



265

Heart Shaped Mouse Pad

Thickness : 3 mm
Product Size : 20 cm



MOBILE ACCESSORIES



CAR-S-BK

Promotional Mobile holder for Cars

Use on car's air vent, suitable for mobile phones with a width of 60 - 89 mm. This flexible holder is easy to use. This holder can rotate 360 round, to adjust according to your desired angle.

Printing Options : Laser Markings





MPP-01

Silicone card holder with sticky screen cleaner

Printing Options : Sublimation

W BK

Peel & Wipe your screens

Easily attach on backside of your mobile



MPS-05

Promotional Mobile Phone Stand

Small & Portable Design, A foldable mobile holder for mobile device and with PVC non-slip stops.
Product Size : 90 x 30 x 10 mm

Printing Options : Full Color UV Printing or Screen Printing

W BK



MPS-06

Promotional Mobile Phone Stand

White plastic mobile stand in a foldable design. Great holder for your full color printing
Product Size : 60 x 98 x 8 mm

Printing Options: Full Color UV Printing or Screen Printing



SR-W

Promotional Selfie Ring Light

Just clip it on your mobile to provide better light when taking a photo or video.
Material: Plastic | Size : 8.5 cm diameter.

Printing Options : Full Color UV Printing



PR-02

Promotional Round Mobile Grip & Stand

Pop-up function for a grip & stand for your mobile devices.
Material: Plastic, ABS. | Size : 4 cm diameter.

Printing Options : Full Color UV Printing

W BK



PR

Promotional Metal Phone Rings

Practical in nature and simple, this mobile phone holder enhances your grip on your smart device as you use it.

Printing Options : Laser Markings

SL BK





BCH-02

Business Card Holder

Card Holder with RFID Protection
Pull down button for easy card retrieval.
Size : 9.5 x 6.3 cm

Printing Options:
• Laser Marking



BCH-01

Steel Business Card Holder

Classic stainless steel that makes it easy for you keep your contact cards clean and unbent.

Printing Options:
• Laser Marking
• Screen Printing

BUSINESS CARD HOLDER GIFT SETS



GS-2

Business card holder and Metal keychain with strap

Product Combination :
(1) Business Card Holder
(2) Metal keychain with leather strap
packed on a Black Carboard Box.



GS-3

Business card holder and Metal keychain.

Product Combination :
(1) Business card holder
(2) Metal keychain with leather strap
packed on a Black Cardboard Box.



GS-4

RFID Protection card holder and Mobile phone ring.

Product Combination :
(1) Card holder with RFID Protection
(2) Promotional metal phone ring
packed on a Black Cardboard Box.



Security

Our Hacksafe Wallets contain a seamless integrated RFID blocking shield that secures your credit cards from unwanted scanning.



Quality

The wallet is a universal thing when it comes to items people carrying their valuables. That's why we offer a good quality wallet made of premium materials.

HSW-01

RFID Protected Business & Credit Card Wallet

ID Window. Two credit card slots.
Business cards compartment.

Folded Size : 75 (w) x 105 (h) mm
Open Size : 150 (w) x 105 (h) mm

Printing Options :
• Laser Marking



HSW-02

RFID Protected Slim Wallet

Eight card pockets. Currency compartment.
Two multi-purpose pockets. Exterior pocket.

Folded Size : 110 (w) x 90 (h) mm
Open Size : 215 (w) x 90 (h) mm

Printing Options :
• Laser Marking



HSW-03

RFID Protected Bi-fold Coin Wallet.

One coin pocket with snap closure.
Three card slots. One slip-in pocket.
Two full-length currency compartments.
One exterior back pocket.

Folded Size : 110 (w) x 90 (h) mm
Open Size : 215 (w) x 90 (h) mm

Printing Options :
• Laser Marking





223-F

**Promotional Glass
Wall Clock for Sublimation**

Glass Round Clock
Best Gift for Full Color Designs
Size : 30 cm

Printing Options :
• Sublimation



590-SBR

Promotional Wall Clock

Silver & Brown Combination
Classy Look Design
Size : 30 cm

Printing Options :
• Full Colour UV Printing
• Screen Printing



CLK-12

Digital Table Clock

Multi Display Digital Clock
Clock, Month, Date & Temperature
with Alarm & Snooze Function
Size : 23 x 14 x 2.5 cm

Printing Options :
• Full Colour UV Printing
• Screen Printing



CLK-01
Promotional Wall Clock

Round Wall Clock with Temperature & Humidity
Size : 31.7 cm

- Printing Options:
- Screen Printing
 - Full color UV Printing



CLK-02
Promotional Wall Clock

Rectangular Wall Clock with Temperature & Humidity
Size : 27 x 32 cm

- Printing Options:
- Screen Printing
 - Full color UV Printing



CLK-03
Promotional Wall Clock

Rectangular Wall Clock in Grey and Black color.
Size : 23 x 33 cm

- Printing Options:
- Screen Printing
 - Full color UV Printing

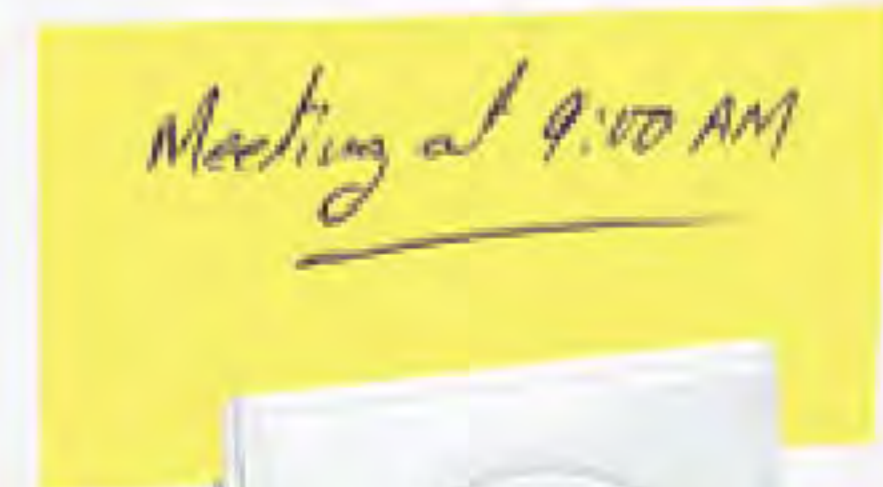

CLK-11
Promotional Magnetic Clip Clock

Simple and stylish design. Can act as a clip for papers, photographs, notes etc. Ideal for promotional purposes. Keep it on your desk and put some memo in it to remind you of some important work.

Multi-purpose digital clock.
Product size : 8 x 4 cm

- Printing Options:
- Full Color UV Printing
 - Screen Printing



Backside



SS-1

Promotional Car Sunshade

Car sunshade is a great help to protect things in the car, and make a cool environment in hot weather. Ideally for front and rear car windshield window. Twist to fold into smaller size for easy storage.
Colour : Silver & Black



SS

Tyvek Material Car Sunshade

Provides perfect heat and sun protection. Mesh-like fabric with UPF of 25+ blocks harmful UV rays. Twist to fold into smaller size for easy storage.

Available in 4 different colours.



TWB

Tyvek Wristband

Tyvek wristbands provide an economical and secure way to identify customers across countless types of events.

- Sequentially number for accountability
- Waterproof / adjustable adhesive closures
- 100% code two, recyclable material
- Secure and tamper resistant
- Strong, Durable and comfortable

Printing Options:
• Screen Printing





014

Silicone Wristband

Size : 100 x 12 mm

Printing Options :
• Screen Printing



SWW

Silicone wrist watch

Size : 235 x 20 mm

Printing Options :
• Screen Printing



ANTI-STRESS BALLS

The act of repeatedly squeezing the ball releases tension and helps to relieve stress. A Great way to promote your Brand while removing stress.



016

Anti-Stress Balls

Material : Closed-cell polyurethane foam rubber
Size : 70 mm

Printing Options:
• Full Color UV Printing
• 1 Color Pad Printing



016-YS

Smiley Face Anti-Stress Ball

Size : 70 mm

Printing Options:
• Full Color UV Printing
• 1 Color Pad Printing



016-H

Heart shaped Anti-Stress Squishy

Size : 65 x 70 x 50 mm

Printing Options:
• Full Color UV Printing
• 1 Color Pad Printing



Cube shape

Cube Stress Balls are available in a five different colours and can be completely personalized with full color UV printing, For greater brand identity.

017

Anti-Stress Cube

Size : 53 mm

Printing Options :

- Full Color UV Printing
- 1 Color Pad Printing



Round Flat Surface

This Stress Balls is in round shape with a flat surface that is best for printing your multi-color logos & designs.

016 -WN

Anti Stress - Round Flat Surface

Size : 75 mm

Printing Options :

- Full Color UV Printing
- 1 Color Pad Printing

Make your Brand visible while on your business or vacation trips.



LUG-02

Promotional Luggage Tag

Plastic Tag with Rubber Attachment
Size : 7.5 x 5.5 cm

Printing Options:
• Full Color UV Printing
• Screen Printing



98180

Inflatable Neck Pillow

Traveling isn't a pain in the neck with this inflatable neck rest that supports your head. The air-filled cushion is covered in washable, soft suede-like material, and deflates so it can be packed in your carry-on, briefcase or backpack.

Product Size : 40 x 27 cm
Packing Size : 17.5 x 12 cm

Printing Options:
• Screen Printing



018

Digital Luggage Scale

Avoid unnecessary excess luggage charges at check-in with our Digital Luggage Scales. Easy to use and lightweight, it's the perfect size to take with you on your travels so you can check your luggage weight before the return journey as well. Measures up to 40 kg. Size : 3 x 10 x 2.5 cm

Printing Options :
 • Full Color UV Printing
 • Screen Printing



98197

Travel set

Travel set. Includes neck pillow, sleeping mask, earplugs and socks. Supplied with 190T pouch. Pouch Size : 150 x 200 mm

Printing Options :
 • Screen Printing



DB-02

Travel Document Bag

Horizontal Pouch for your passport & other documents. Dimensions : 27.5 x 13 cm

Printing Options : Heat Transfer or Screen Printing



DB-03

Leather Passport Cover

Dorniel Designs Pouch for your passport protection. Dimensions : 10 x 14 cm

Printing Options : Screen Printing or Debossing

Your logo should appear even in training or sports events.

CT-W

Instant Cooling Towel

High-tech, soft & chemical free fabric.
 3 steps; soak, wring out excess & snap!
 Use wet to get instant cool. Use Dry to absorb sweat.
 Size : 30 x 100 cm

Printing Options : Heat Transfer



99962
Gym towel
 Cotton: 430 g/m².
 Dimensions : 300 x 500 mm
 Printing Options :
 Heat transfer or Embroidery



99963
Gym towel
 Cotton: 430 g/m².
 Dimensions : 200 x 800 mm
 Printing Options :
 Heat transfer or Embroidery



99022

Promotional Wrist band

Absorbent band material worn around the wrist to soak up sweat, especially by participants in sport with a round area for your logo.
 Size : 75 x 78 mm

Printing Options :
 • Heat Transfer



TM-007

Promotional Sports Bottle with Straw.

Material : Tristan Plastic with Silicone
 Size : 75 x 230 mm
 Capacity : 750 ml

Printing Options :
 • 1 Color Screen Printing
 • Full Color UV Printing



SB-09

Promotional Sports Bag

Grey interior, 1 zipper pocket, shoe compartment, mesh pocket for bottles, adjustable shoulder strap. Dimensions : 53 x 27 x 24.5 cm

Printing Options : Heat Transfer or Screen Printing



97207

Smartphone armband

Smartphone armband. High density soft shell. Reflective elements with adjustable velcro. For 5.5" smartphones. Size : 440 x 175 mm

Printing Options : Screen Printing



98086

Fitness set

Your promotional fitness set. Includes elastic and skipping rope. Supplied with 190T pouch. Pouch size : 210 x 270 mm

Printing Options : Screen Printing



Make your Logo
shine even on our
Personal items.



92717

Cosmetic bag

A pouch for your personal things.
Microfiber and mesh.
Size : 210 x 130 x 85 mm

Printing Options:
• Heat Transfer
• Screen Printing



94853

Promotional Mirror

A type of mirror created and
designed in various colors,
in a round shape for portability.
Size : 60 mm (dia.)

Printing Options:
• UV Printing
• Screen Printing



94851

Promotional Lip balm

Size : 19 x 68 mm

Printing Options :
• Pad Printing



010

Promotional Nail Clipper

Promote your Logo in Full color
4 in 1 : Keychain, Clipper
Bottle Opener & Nail File.

Printing Options :
• Full Color Printing with Epoxy



94843

Manicure set

A set of items used in the treatment and care of the hands and fingernails.
Includes 4 pieces of tools.
Size : 100 x 53 x 20 mm

Printing Options :
• Full color Printing with Epoxy
• Full Color UV Printing



Promoting your Brands on Health Care Products



9496

First aid kit with pouch.

First aid kit. Includes 4 plasters, 2 alcohol wipes, 2 non-woven swab, 2 rectangular plaster, 2 gauze, adhesive tape, scissor and tweezers. Supplied in a pouch.
Size : 180 x 130 x 50 mm

Printing Options :
• Heat Transfer



94353

Heat pouch

Used for warming of parts of the body in order to manage pain. Localized application of heat causes the blood vessels in that area to dilate, enhancing perfusion to the targeted tissue. Generates heat automatically. Reusable.
Size : 88 x 110 mm

Printing Options :
• Screen Printing
• Full Color UV Printing



PILL-B1

Promotional Pill Box

White Plastic Box for Medicine
Slide to open box.
Size : 9 x 5.5 cm

- Printing Options :
- Full Color UV Printing
 - Screen Printing



94352

Promotional Plaster holder

Plastic case for Medical Plaster
Size : 41 x 102 x 10 mm

- Printing Options :
- Full Color UV Printing
 - Screen Printing



016-H

Heart shaped Anti-Stress Squishy

Size : 65 x 70 x 50 mm

- Printing Options :
- 1 Color Pad Printing
 - Full Color UV Printing



82092

BMI Scales

Plastic tape measure with
Body Mass Index calculator, 1,5 m.

- Printing Options :
- Full Color UV Printing



TM-009

Promotional Travel Bottle

Matte texture bottle.
Material : Stainless Steel | Size : 70 x 270 mm | Capacity : 500 ml

Printing Options :
• Screen Printing



144

Sublimation Bottles

Material : Stainless Steel coated for sublimation
Size : 70 x 270 mm | Capacity : 500 ml

Printing Options :
• Sublimation



TM-004

PS Bottle with Stainless Steel Cap & Base

Material : AS Plastic & Stainless Steel
Size : 68 x 245 mm | Capacity : 750 ml

Printing Options :
• Screen Printing
• Full Color UV Printing

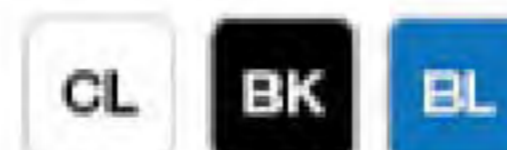



140

Promotional Sports Bottle

Matte texture aluminum body with carabiner clip
 Material : Aluminum | Size : 73 x 260 mm | Capacity : 750 ml

Printing Options :
 • Screen Printing



TM-008

Promotional Bottle with Sleeve.

Sports bottle. Glass and stainless steel with softshell coloured sleeve.
 Material : Glass & Steel | Size : 65 x 225 mm | Capacity : 500 ml

Printing Options :
 • Heat Transfer
 • Screen Printing

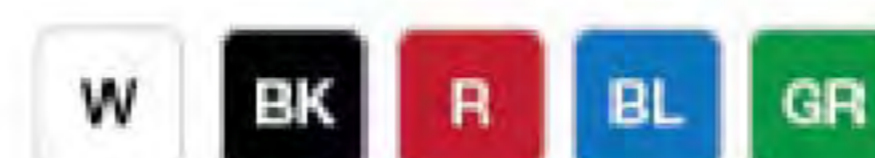



TM-003

A5 Size Memo Promotional Bottle.

A5 Memo water bottles are designed to fit stylishly into handbags, backpacks, laptop bags and more. Slim design to fit where other bottles cant.

Material : AS Plastic | Size : 130 x 213 x 32 mm | Capacity : 420 ml

Printing Options :

- Screen Printing
- Full Color UV Printing



TM-002

Promotional Bottle with Fruit Infuser.

Enjoy the health benefits of Infused water everywhere you go! Make a flavored water with your choice of fruits!

Material : PS & Tristan | Size : 68 x 245 mm | Capacity : 700 ml

Printing Options :

- Screen Printing
- Full Color UV Printing



TM-007

Promotional Travel Bottle with Straw.

Material : Tristan Plastic with Silicone
 Size : 75 x 230 mm
 Capacity : 750 ml

- Printing Options:
 • 1 Color Screen Printing
 • Full Color UV Printing



Innovative Lid with Integrated straw.



TM-001

Promotional Travel Mug

Double wall mug with clear outer wall to display the insert paper design, leak proof cap, suitable for office, cars, and for your everyday use.

Material : AS Plastic
 Size : 70 x 180 mm

- Printing Options:
 • Full color digital printing





TM-005

Promotional Double wall Travel Mug with clear lid

Plastic inner wall with coloured stainless steel outer wall & a clear lid.
Material : Stainless Steel & AS Plastic
Size : 75mm (dia) x 190mm (height) | Capacity : 500 ml

Printing Options :

- 1 color Screen Printing
- Full color UV Printing

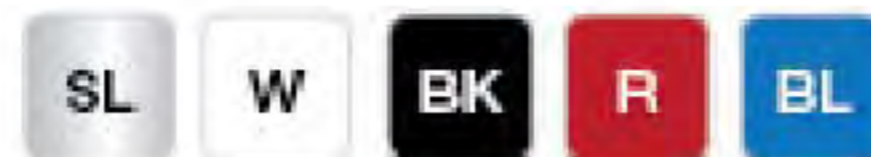

TM-006

Promotional Stainless Steel Travel Mug

Stainless steel inner wall with a clear outer wall to display the insert paper design, leak proof cap, suitable for office, cars, and for your everyday use.
Material : AS Plastic & Stainless Steel
Size : 85mm (dia) x 195mm (height) | Capacity : 470 ml

Printing Options :

- Full color digital printing





TM-020

Wheat Straw Cup with Silicone lid and band

A combination of wheat straw and PP material. Cup in natural color with silicone center band and lid in matching color silicone. Compostable and biodegradable
 Material : Wheat Straw, PP & Silicone
 Size : 95mm (Dia) x 115mm (Height) | Capacity : 350 ml

Printing Options :
 - Screen Printing



WHEAT STRAW MATERIAL



TM-021

Bamboo Fiber Cup with Silicone lid and band

A combination of natural bamboo fibers and PP material. Cup in grey color with silicone center band and lid in different coloured silicone. Compostable and biodegradable
 Material : Bamboo Fiber, PP & Silicone
 Size : 95 mm (Dia) x 115mm (Height) | Capacity : 350 ml

Printing Options :
 - Screen Printing



BAMBOO FIBER MATERIAL





LUN-WS

Promotional Wheat Straw Lunch Box

Lunch box made from a combination of wheat straw & PP material. BPA free material, and suitable for dishwasher, microwave oven and freezer. Includes an band with a fork and a knife. Product Dimension : 165 x 120 x 55 mm

- Printing Options:**
- Full Color UV Printing
 - Screen Printing



LUN-01

Promotional Lunch Box

Lunch box with two compartment. Fork & knife included, made from PP material. BPA Free. Volume : 1500 ml/52 oz. Size : 230 x 160 x 70 mm

- Printing Options:**
- Screen Printing
 - Full color UV Printing





SB-01

Promotional String Bag

Material : Polyester | Size : 34 x 42 cm
Available in 10 different colors.

Printing Options :

- Heat Transfer
- Screen Printing



CSB-10

Canvas Drawstring Bag

Material : Canvas | Size : 34 x 42 cm

Printing Options : Heat Transfer or Screen Printing



CSB-09

Recycled Cotton Drawstring Bag

Material : Recycled Fabric | Size : 37 x 40 cm

Printing Options : Screen Printing



92547

Promotional Shoulder Bag

Shoulder bag with front pocket.
Adjustable shoulder strap.
Dimensions : 180 x 220 x 70 mm

Printing Options : Heat Transfer or Screen Printing



SB-04-GY

Promotional Backpack

Basic everyday backpack.1 main zipper & 1 side zipper.
Padded shoulder strap, Color : Grey | Interior Color : Black
Dimensions : 40 x 45 x 17 cm

Printing Options : Heat Transfer or Screen Printing



SB-02

Promotional Backpack

Small Backpack with front Pocket
One main compartment, Two side
Mesh pocket, padded shoulder strap

Printing Options :
• Heat Transfer
• Screen Printing





SB-03

Dorniel Designs Promotional Backpack

15.6" Laptop Backpack
 Cushion for Laptop protection
 Tablet Pocket, Padded shoulder strap
 Separate space for Folders & Files.
 2 Zipper Laptop Backpack
 Color : Grey | Interior Color : Black
 Dimensions : 30 x 40 x 10 cm

Printing Options :
 • Heat Transfer



SB-05

Dorniel Designs Promotional Backpack

15.6" Laptop Backpack , Cushion for Laptop protection
 Front, Back, Side & Strap Pockets, Padded shoulder strap
 Full Black with Leather Backpack, Dimensions : 35 x 45 x 15 cm

Printing Options :
 • Heat Transfer



BAG



SB-09

Promotional Sports Bag

Grey interior, 1 zipper pocket, shoe compartment, mesh pocket for bottles, adjustable shoulder strap. Dimensions : 53 x 27 x 24.5 cm

Printing Options :
• Heat Transfer



SB-07

Tangram Multifunction Bag

2 front pockets. Inside paddings. Adjustable shoulder strap, with reinforcement. Dimensions : 38 x 30 x 8 cm

Printing Options :
• Screen Printing
• Heat Transfer





DB

Promotional Document Bags

Great for storing your folders, paper works & other stuffs.
 Dimensions : 37 x 27 cm
 Available in 6 different colours.

Printing Options :
 • Heat Transfer
 • Screen Printing



Document / Laptop Bag

Dedicated for your business trips.



SB-06

Dornel Designs Document Bag

Interior with cushion protection for your Laptop/Tablets.
 Front & Back zipper pocket, Padded shoulder strap
 Dimensions : 35 x 26 x 7 cm

Printing Options :
 • Heat Transfer



DB-02

Travel Document Bag

Horizontal Pouch for your passport, receipts & other documents.
Dimensions : 27.5 x 13 cm

Printing Options :
• Heat Transfer



CB-02-BK

Cooler Backpack

Zippered main compartment with insulation foam interior.
Adjustable shoulder strap.
Dimensions : 30 x 52 x 25 cm

Printing Options :
• Heat Transfer or Screen Printing



CB-BK

Promotional Cooler Bag

Great for summer time or just simply for any simple occasion.
Zippered main compartment with insulation foam inside.
Dimensions : 20 x 18 x 13 cm

Printing Options :
• Heat Transfer

CSB

Promotional Cotton Bags

Material : Cotton
 Dimensions : 37 x 40 cm
 Available in 6 different colours

Printing Options :
 - Heat Transfer
 - Screen Printing



CSB-04

8 oz Bleached Laminated Cotton Bags

Dimensions : 20 x 33 x 16 cm

Printing Options :
 Heat Transfer or Screen Printing

CSB-05

Promotional Cotton Bags

Dimensions : 48 x 40 x 14.5 cm

Printing Options :
 Heat Transfer or Screen Printing

JUTE & COTTON

JSB-11

Promotional Jute with Cotton Bag

Jute bag with cotton on side area to highlight your single or full color logo. Cotton flat handles. Dimensions : 40 x 35 x 15 cm

Printing Options :

- Heat Transfer
- Screen Printing



JSB-08

Jute Bags with cotton pocket

Jute bag with cotton pocket suitable for single or full color printing. White reinforced cotton handles with resistance up to 10kg weight. Dimensions : 45 x 35 x 12 cm

Printing Options :

- Heat Transfer
- Screen Printing



JSB-09

Jute Bags with cotton sides

A vertical size Jute bag with cotton on both sides for single or full color printing. Flat handles. Dimensions : 34 x 28 x 14 cm

Printing Options :

- Heat Transfer
- Screen Printing

JUTE MATERIAL

This strong and sturdy material has been used to create durable and attractive items such as our Jute shopping bags. Jute bags are often tightly woven and firmly sewn to reinforce their structure and allow them to be free standing, and most regularly have a strong rectangular base



JSB-01

Promotional Jute Bags

Natural coloured jute bag with an attractive wooden lock button.
Dimensions : 43 x 33 x 19 cm

Printing Options:
• Heat Transfer
• Screen Printing

JSB

Promotional Jute Bags

Jute material with colours.
Dimensions : 35 x 30 x 20
Available in 4 different colours

Printing Options:
• Heat Transfer
• Screen Printing





JSB-07

Promotional Jute Bag

Square shaped bag in full Jute material. Flat handle.
Dimensions : 30 x 30 x 19 cm

- Printing Options:
- Heat Transfer
 - Screen Printing



JUTE



JSB-06

Promotional Jute Bags

Jute bag with white side area to highlight your single or full color logo. With short, reinforced handles and resistance up to 10kg weight.
Dimensions : 40 x 33 x 15 cm

- Printing Options:
- Heat Transfer
 - Screen Printing



NW-SUB

Sublimation Bag

White non-woven bag for full color sublimation printing.
Dimensions : 37 x 39 cm

- Printing Options:
- Heat Transfer



NW-SUB-A4H

Sublimation Bag

Dimensions : 32.5 x 25 x 12 cm
White non-woven bag for full color sublimation printing.



NW-SUB-A5

Sublimation Bag

Dimensions : 19 x 24 x 12 cm
White non-woven bag for full color sublimation printing.

SUBLIMATION BAG FOR FULL COLOR PRINTING



NW-A4H-BK

Non-woven Bag

Dimensions : 32.5 x 25 x 12 cm
Black non-woven bag for screen printing.



NW-A5-BK

Non-woven Bag

Dimensions : 19 x 24 x 12 cm
Black non-woven bag for screen printing.



NW-SUB-6V

Sublimation Bag

Dimensions : 30 x 38 x 12 cm
White non-woven bag for full color sublimation printing.



Vertical Non-woven Bags

Non-woven bag in 100gsm, in a varied range of colors. With reinforced short handles and heat-sealing finish. Size : 30 x 38 x 12 cm

Printing Options: Screen Printing



Horizontal Non-woven Bags

Non-woven bag in 100gsm, in a varied range of colors. With reinforced short handles and heat-sealing finish. Size : 43 x 33 x 12 cm

Printing Options: Screen Printing

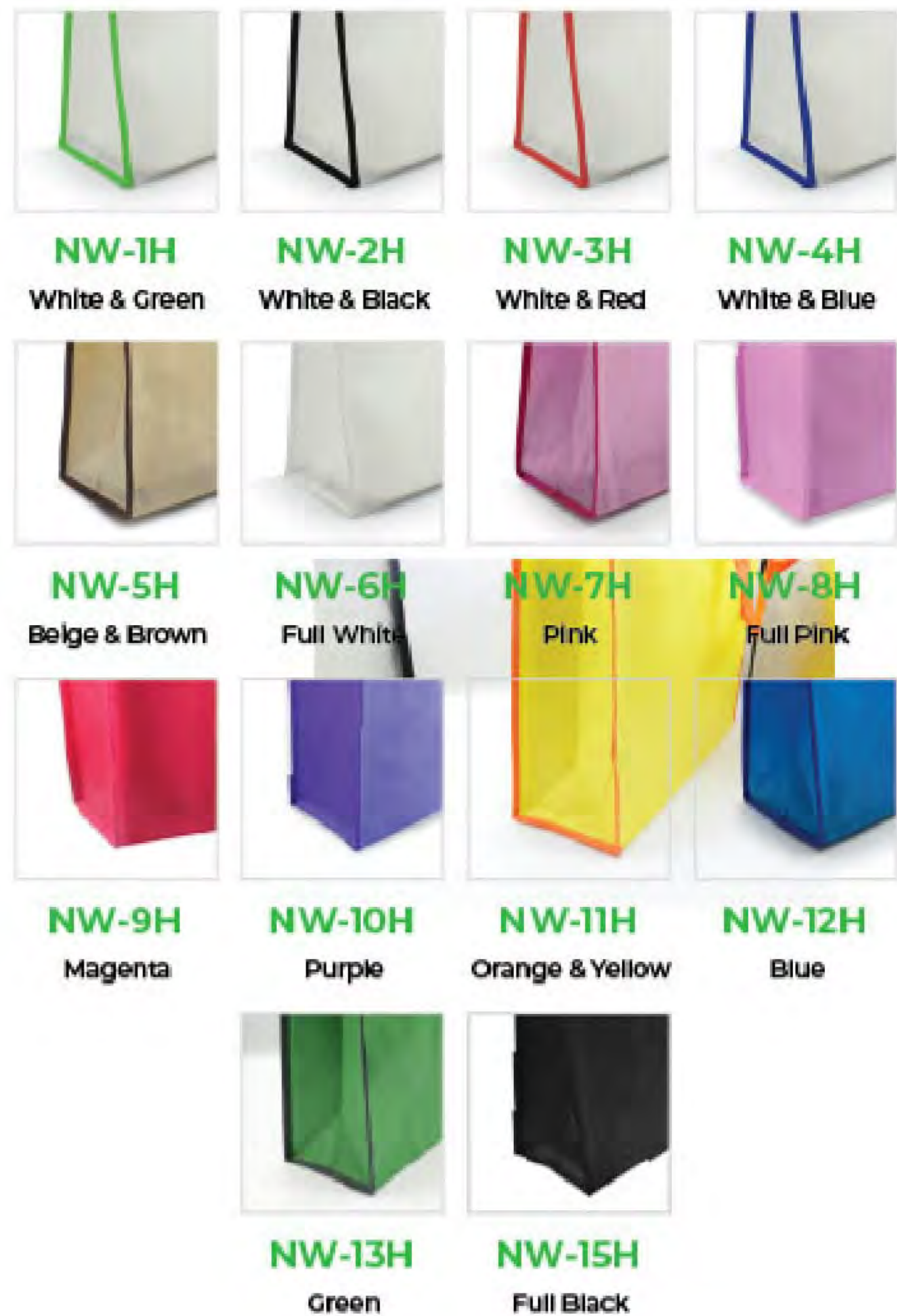

WA4-N

Horizontal White Paper Shopping Bag

Dimensions : 38 x 24 cm
Material : 350 GSM
Full White paper bag for screen printing.



RA3V

A3 Vertical Red Paper Shopping Bag

(A3) : 35 x 44 x 10 cm
for screen printing.



BLA3V

A3 Vertical Blue Paper Shopping Bag

(A3) : 35 x 44 x 10 cm
for screen printing.



SLA3V

A3 / A4 Vertical Silver Paper Shopping Bag

(A3) : 35 x 44 x 10 cm
(A4) : 26 x 33 x 13.5 cm
for screen printing.



RA3H

A3 Horizontal Red Paper Shopping Bag

(A3) : 44 x 35 x 10 cm
for screen printing.



BLA3H

A3 Horizontal Blue Paper Shopping Bag

(A3) : 44 x 35 x 10 cm
for screen printing.



SLA3H / SLA4H

A3 / A4 Horizontal Silver Paper Shopping Bag

(A3) : 44 x 35 x 10 cm
(A4) : 33 x 26 x 13.5 cm
for screen printing.

PROMOTE YOUR BRANDS

BY HEAT TRANSFER OR EMBROIDERY



OTTOMAN



CAP-O

**Promotional Caps
Ottoman Material**

5 Panel Ottoman
Cap with Flexible Fit band

02

01



FLEXIBLE FIT

SOFT MESH

CAP-M

**Promotional Caps
Soft Mesh Material**

5 Panel Soft Mesh Sandwich Cap with
Flexible Fit Elastic Band



FLEXIBLE FIT



BASICS



CAP-C-01

**Full White Adult Size
Regular Cotton Cap**

5 Panel Cotton Cap
with Velcro backstrap closure



CAP-KC-01

**Full White Kid's Size
Heavy Brushed Cotton Cap**

5 Panel Children's Brushed Cotton Cap
with Velcro backstrap closure



YOUR LOGO OR DESIGN

In Full Color Heat Transfer , Screen Printing or Vinyls



Ready-made or Customized | Large selection of colours & materials



Ready-made or Customized
Large selection of colours & materials



Available in Different Sizes



SV-01

Reflective Safety Vest

High visibility reflective vest for all work sites and job hazards. Approved according to CE safety regulations. With double reflective strip around the body and velcro closures. ISO Certified, European Standard, 120 GSM Polyester

Printing Options :
 • Screen Printing
 • Sublimation



99800-W

Promotional Aprons

A protective garment worn over the front of one's clothes. A great way to promote your brands in a cafe, restaurant or even on personal use. 100% cotton material. Size : 600 x 900 mm | Pocket: 250 x 200 mm

Printing Options :
 • Heat Transfer



625

Promotional Button Badges

Size : 75 mm
 Backside with Pin



405

Promotional Button Badges

Size : 56 mm
 Backside with Pin



403

Promotional Button Badges

Size : 44 mm
 Backside with Pin



401

Promotional Button Badges

Size : 32 mm
 Backside with Pin



406
Hexagon Button Badges
 Size : 65 x 60 mm
 Backside with Pin



629P (Plastic)
629M (Metal)
Oval Shaped Button Badges
 Size : 45 x 70 mm
 Backside with Pin



630
Keychain Button Badges
 Size : 44 mm
 with Keychain ring attachment



405-N
Button Badges with Bottle Opener
 Size : 56 mm
 Backside with Ring



627
 Size : 56 mm
626
 Size : 44 mm
Magnetic Button Badges
 Available in 2 Sizes
 Backside with Magnet



643
Photo Stander
 Size : 158 mm



640-P
Button Plate
 Size : 158 mm



642
Button Clock
 Size : 158 mm



644
Button Coin Box
 Size : 158 mm



CHILDREN'S GIFT

Are kids a part of your next giveaway effort?
We offer a Vast range of Promotional Items for kids to choose from.



Children T-shirts

Ready-made or Customized
Large selection of colours & materials



CAP-KC-01

Full White Kid's Size Promotional Cotton Cap

5 Panel Children's Brushed Cotton Cap
with Velcro backstrap closure



CHILDREN'S GIFT

Promotional product for kids!



SB-01

Promotional String Bag

Material : Polyester | Size : 34 x 42 cm
Available in 10 different colors.

Printing Options : Screen Printing, Sublimation on white



SB-02

Promotional Backpack

Slim Backpack with front zipper pocket & side mesh pockets
Available in 5 different colors.

Printing Options : Heat Transfer



92619

Children's colouring drawstring bag

Children's colouring drawstring bag. Non-woven: 80 g/m².
With printed design and interior pocket.
4 markers included. Size : 300 x 350 mm

Printing Options : Screen Printing



58412

Children's Cooler Bag

Cooler bag for children. Adjustable webbing strap.
Capacity up to 4,5 L.
Size : 200 x 200 x 110 mm

Printing Options : Heat Transfer



015

5 Colour Highlighter

Material : Plastic
Blue, Green, Yellow, Orange and Pink Highlighter.

Printing Options :
• Full Color UV Printing
• Screen Printing



SPN-W

Promotional Spinners

Material : Metal & Plastic | Size : 70 mm
A fidget spinner is a toy that consists of a ball bearing in the center of a multi-lobed flat structure made from metal & plastic designed to spin along its axis with little effort.

Printing Options :
• Full Color Printing with epoxy



SPN-H

Fidget Spinner with Highlighter

Material : Plastic | Size : 80 mm
Combination of a Spinner & Highlighter

Printing Options : Full Color UV Printing or Screen Printing



GFK-03

Promotional Pencils with Cardboard Box

Set of 12 different colours.

Printing Options : UV Printing or Screen Printing



GFK-02

Promotional Crayons with Cardboard Box

Set of 12 different colours.

Printing Options : UV Printing or Screen Printing



CHILDREN'S GIFT

Promotional product for kids!



GFK-05

Wooden Case with Ruler, Sharpener & Coloured Pencils.

Dimensions : 20.8 x 4 x 3 cm

Printing Options :

- Full Color UV Printing
- Screen Printing

91758

Promotional Colouring Set

Includes 6 coloured pencils, 1 pencil sharpener and 15 colouring cards.
Size : 73 x 89 x 12 mm

Printing Options :

- Full Color UV Printing
- Screen Printing



91932

Promotional Writing Set

Writing set. Includes 16,5 cm ruler, 2 pencils, 1 rubber and 1 pencil sharpener.
Supplied with cardboard pouch.
Pouch Size : 190 x 45 x 20 mm

Printing Options :

- Screen Printing

GFK-04

Natural Color Pencil with Eraser

Printing Options :

- Screen Printing





93574

School geometry set

Plastic box with 9 pieces school accessories
 1 compass, 1 rubber, 1 sharpener, 1 pencil, 1 mechanical pencil,
 10 mines 0.5, 1 ruler, 1 set square and 1 protractor.
 Box Size : 165 x 68 x 25 mm

Printing Options :
 • Full Color UV Printing
 • Screen Printing



GFK-01

Pencil Pouch

Non-woven pouch material with zipper.
 Great for single or multi-color printing

Printing Options :
 • Screen Printing
 • Heat Transfer



MB-05

A5 Size PU Leather Notebook

PU Cover notebook with calendar, pocket, pen holder
 bookmark ribbon & strap.



MB-06

A6 Size PU Leather Notebook

PU Cover notebook with bookmark ribbon & strap.





CHILDREN'S GIFT

Promotional product for kids!



080

Promotional Writing Board

Magnetic white board with marker & eraser.

- Printing Options :
- Full Color UV Printing
 - Screen Printing



PP-04

Cardboard Puzzle

Heart Shaped
Size : 19 x 19 cm



PP-06

Cardboard Puzzle

126 pcs puzzle part
Size : 27 x 18 cm



PP-07

Cardboard Puzzle

108 pcs puzzle part
Size : 34 x 26 cm



PP-05

Cardboard Puzzle

80 pcs puzzle part
Size : 20 x 14.5 cm



PP-02

Hardboard Puzzle

60 pcs puzzle part
Size : 24.6 x 17 cm



PP-03

Hardboard Puzzle

30 pcs puzzle part
Size : 24.6 x 17 cm



PP-01

Plastic Puzzle

15 slidable square
Size : 7.5 x 9 cm

Fun, Educational, Mind Exercise

Puzzles help children's development & also a good way to promote your Logo



CT-W
Instant Cooling Towel

Soft & Chemical free fabric.
Size : 30 x 100 cm
Printing Options : Sublimation



95504
Stuff toy

Supplied with polyester t-shirt for your full color logo printing.
Printing Options : Heat Transfer



190-3 190-4 190-5 190-6 190-7 190-9

Animal Ceramic Mug

White mug in a animal handle design, & coloured trim on top.
Size : 105 mm (height) x 80 mm (dia)
Printing Options : Sublimation



142
Ceramic Coin Bank

Mug like material for full color printing.
Size : 98 mm (height) x 80 mm (dia.)
Printing Options : Sublimation



644
Photo Button Coin Bank

Aluminum & Plastic Material
Size : 168 mm
Printing Options : Digital Printing



ECO

FRIENDLY

PRODUCTS

ECO products are those products that provide environmental benefits while protecting public health and environment over their whole life cycle, from the extraction of raw materials until the final disposal.



USB-38 Bamboo USB Flash Drive

Swivel USB flash drive manufactured from eco-friendly bamboo which is a renewable resource. A material which produces unavoidable variances in the grain pattern, colour and branding.
Size : 65 x 18 mm | Capacity : 4 or 8 GB.



USB-13 Bamboo USB Flash Drive

Durable and attractive, this wood usb flash drive has an outer shell crafted from bamboo- a sustainable material that also looks good, feels smooth and is compact.
Size : 60 x 30 mm | Capacity : 4 or 8 GB.



WWS GWS

068 Bamboo with Wheat Straw Pen

Ballpoint Pen with body made of bamboo and a wheat straw clip & tip. Push-button mechanism.



069-S Bamboo Pen

A combination of Nature friendly and Style in a pen. Barrel is made from bamboo with a silver clip, tip and push-button.



BK S R BL

067 Paper Pen

Pen made out of recycled paper with a combination of plastic tip and a stylish metal clip.



074 Wheat Straw Pen

Ballpoint Pen with body made of wheat straw and PP. Great barrel texture with stylish & large clip design suitable for single or multi-color printing



W BK BL GR



071 Wheat Straw & Cork Pen

This recycled ballpen is made out of wheat straw with cork barrel. Push-button mechanism. With its large clip its a great way to promote your logo in single or multi-color printing.



W BK BL GR



078 Coffee Pen

Ballpoint Pen with body made from coffee material. Stylish Barrel texture with push-button mechanism. Large clip design for your Single or Multi-color printing.



070 Wheat Straw Pen with Stylus

Ballpoint Pen with body made of of wheat straw and PP. Black clip & tip, twist mechanism, stylus touchscreen top.



GFK-04 Promotional Pencil

Promotional Wooden pencil with round body in natural finish and rubber eraser in white colour.



NATURE PRODUCTS

RNP-11 Wood Design Notebook with Sticky Notes & Pen

Wood like notebook cover with recycled cardboard pen. Eco design with soft touch covers & elastic closure. With built-in ball pen holder, 70 sheet notepad with striped layout, 25 large and 125 mini sticky notes. Size : 105 x 155 x 23 mm



RNP-04 Recycled Notepad with Pen

Ring notepad with soft-touch covers in resistant bicolor recycled cardboard. With elastic fastening on the cover and recycled pen in matching color. Cover Material : Cardboard | Size : 140 x 90 mm



R

GR

BK

BL



RNP-02 Notepad with Sticky Notes

Ring notepad with recycled cardboard in a magnetic flap. 3 different sizes of sticky notes in different colours. Cardboard cover available in 4 colours. Size : 15 x 9 cm



R

GR

BK

BL



GFK-05 Writing Set

Coloured pencil in natural color body, wooden ruler, eraser, sharpener packed in a wooden case.
Dimensions : 20.8 x 4 x 3 cm



RNP-07 ECO paper cube box

Cardboard box which flips open to reveal a handy sticky note set. It includes a block of multi coloured note paper, a pad of yellow adhesive notes, five pads of different coloured adhesive flags and a pen / accessories holder.



RNP-09 Promotional Writing Set

Eco friendly tri-fold writing set with strap closure. Contains 50 sheet notepad in the center, pocket and sticky notes on the right panel, Eco friendly pen, ruler, 2pcs. natural coloured pencils, sharpener and eraser on the left panel.

RNP-03 Recycled Pad Holder & Pencil

Flap box that contains sheets of pad made from recycled materials. Also includes a Pencil in natural color body.
Size : 11 x 10 x 3 cm





NATURE PRODUCTS



MB-05-C A5 Size Cork Cover Notebook with Pocket & Pen Holder

Eco friendly, natural cork texture hard covers notebook. elastic band and fabric bookmark in sober black color.
Cover Material : Cork | Size : A5 (140 x 210 x 20 mm)



R



GR



BK



BL

RNP-05 Eco Friendly Material A5 Size Notebook with Pen holder.

Size : A5 (140 x 210 x 20 mm)



R



GR



BK



BL

RNP-01 Recycled Notebook with Stylus Pen

Ring notebook with soft-touch covers in resistant bicolor recycled cardboard, elastic fastening on the cover and ball pen in matching color recycled cardboard.
Cover Material : Cardboard | Size : 160 x 210 mm



RNP-10 Notepad with Sticky Notes

Ring notepad in cardboard covers with smiley cut out, showing a first layer with a sticky 2 types of note & below is the second layer with the notepad is striped format.



RNP-08 Pad Holder with Sticky Note & Recycled Paper Pen

Eco friendly material notepad with a flap area showing a different color of sticky notes, also includes a pen with a recycled paper barrel.

RNP-06 Recycled Notebook with Sticky Note & Cardboard Pen

Ring notepad with recycled cardboard covers. Bold cover design with a die-cut showing the colors of the sticky notes inside. Notepad sheets in a striped format with a cutted area for a eco friendly promotional pen made from cardboard.

Size : 14.5 x 17.5 cm





NATURE PRODUCTS



JSB-08 Jute Bags with cotton pocket

Jute bag with cotton pocket suitable for single or full color printing. White reinforced cotton handles with resistance up to 10kg weight. Dimensions : 45 x 35 x 12 cm



JSB-01 Promotional Jute Bags

Natural coloured jute bag with an attractive wooden lock button. Dimensions : 43 x 33 x 19 cm



JSB-06 Promotional Jute Bags

Jute bag with white side area to highlight your single or full color logo. With short handles & resistance up to 10kg weight. Dimensions : 40 x 33 x 15 cm



JSB-09 Jute Bags with cotton sides

A vertical size Jute bag with cotton on both sides for single or full color printing. Flat handles
Dimensions : 34 x 28 x 14 cm



JSB-07 Promotional Jute Bags

Square shaped bag in full Jute material. Flat handle.
Dimensions : 30 x 30 x 19 cm



CSB-10 Canvas String Bag

Drawstring bag, consisting of a cotton cord that goes through a seam around an opening & closing the bag.
Dimensions : 34 x 42 cm

JSB Promotional Jute Bags

A Jute bag with colour on corners, bottom & handle part. Cream color on sides for single or full color printing.
Dimensions : 35 x 30 x 20 cm



JSB-02

JSB-03

JSB-04

JSB-05





NATURE PRODUCTS



CSB-08 Recycled Cotton Bag

Manufactured with Recycled cottons & waste fabric material. A large unfastened bag with parallel handles that emerge from the sides. Dimensions : 37 x 40 cm



CSB-09 Recycled Drawstring Bag

Drawstring bag, made from recycled cottons & waste fabric material, consisting of a cotton cord that goes through a seam around an opening & closing the bag. Dimensions : 37 x 40 cm





TM-020 Wheat Straw Cup with Silicone lid and band

A combination of wheat straw and PP material. Cup in natural color with silicone center band and lid in matching color silicone. Compostable and biodegradable
Size : 95 (Dia) x 115 (Height) mm

TM-021 Bamboo Fiber Cup with Silicone lid and band

A combination of natural bamboo fibers and PP material. Cup in grey color with silicone center band and lid in different coloured silicone. Compostable and biodegradable
Size : 95 (Dia) x 115 (Height) mm

LUN-WS Promotional Wheat Straw Lunch Box

Lunch box made from a combination of wheat straw & PP. BPA free material, and suitable for dishwasher, microwave oven and freezer. Includes an band with a fork and a knife.
Product Dimension : 165 x 120 x 55 mm



Promotional Gift Sets

Almost every business uses promotional products to please its clients with gifts.

We offer the Best and Ideal, Giveaways for Corporate events, business promotions & more.



PN33

Amabel Designs Gift set Metal Pen & Keychain

Product Combination :

- (1) Roller Pen with Scheinder Refill
- (2) Elegant Metal Keychain

packed on a Black Amabel Designs Leather Box

SWAROVSKI ELEMENTS



Schneider Refill



Gift Sets



GS-1

Leather wallet, Metal keychain with leather strap and Metal pen.

Product Combination :
(1) Promotional leather wallet
(2) Metal keychain with black leather strap
(3) Black & Silver promotional metal pen.
packed on a Black Carboard Box.



GS-2

Business card holder and Metal keychain with leather strap

Product Combination :
(1) Business Card Holder
(2) Metal keychain with black leather strap
packed on a Black Carboard Box.



GS-3

Business card holder and Metal keychain with leather strap.

Product Combination :
(1) Business card holder
(2) Metal keychain with leather strap
packed on a Black Cardboard Box.



GS-4

RFID Protection card holder and Mobile phone ring.

Product Combination :
(1) Card holder with RFID Protection
(2) Promotional metal phone ring
packed on a Black Cardboard Box.

Gift Sets

Almost every business uses promotional products to please its clients with gifts.

GS-05

Promotional Gift Set #05

Contains total of 5 products as listed below;

- MB-06-BK** : Black A6 Size PU Notebook
- JU-WM-BK** : Black Wireless Mouse
- JU-WCP-02** : Wireless Charger
- PN42-BK** : Rubberized Metal Pen with Stylus
- USB-20-BK** : Black Slide USB Flash Drive



GS-06

Wireless Products - Technology Gift Set #06

Contains total of 2 products as listed below;

- JU-WPB-10000** : 10,000 mAh Wireless Powerbank with Suction Cup
- JU-WCP-02-BK** : Black Promotional Wireless Charger



We offer the Best and Ideal, Giveaways for Corporate events, business promotions & more.

Gift Sets

GS-07

Promotional Gift Set #07

Contains total of 5 products as listed below;

- MB-06-BK : Black A6 Size Notebook
- PN27-BK : Black Metal Pen with Stylus
- BCH-02 : Business Card Holder
- MPS-05-BK : Black Mobile Phone Stand
- PR-BK : Black Metal Phone Ring



GS-08

Promotional Gift Set #08

Contains total of 5 products as listed below;

- MB-06-W : White A6 Size Notebook
- PN26-W : White Metal Pen with Stylus and LED light
- JU-PB-5000-W : 5,000 mAh Mini Size Promotional Powerbank
- MPS-05-W : White Mobile Phone Stand
- USB-20-W : White Slide USB Flash Drive



Gift Sets

Almost every business uses promotional products to please its clients with gifts.

GS-09

Promotional Gift Set #09

Contains total of 6 products as listed below;

- BCH-01** : Steel Business Card Holder
- USB-TI-M** : Aluminum USB Flash Card
- PN27-SL** : Silver Metal Pen with Stylus
- KH-3** : Promotional Metal Keychain
- PR-SL** : Silver Metal Phone Ring
- AF-001-SL** : Silver Flash Light



GS-10

Technology Gift Set #10

Contains total of 2 products as listed below;

- JU-PB-4000-CR** : 4,000 mAh Rubberized Powerbank with Crystal
- USB-59** : Crystal USB Flash Drive (Capacity: 8 or 16 GB.)



We offer the Best and Ideal, Giveaways for Corporate events, business promotions & more.

Gift Sets

GS-11

Technology Gift Set #11

Contains total of 2 products as listed below;

- JU-WM-BK : Promotional Wireless Mouse
- USB-6I-BK : 4 in 1 : Multi-function USB Pen



GS-12

Technology Gift Set #12

Contains total of 2 products as listed below;

- JU-WM-W : Promotional Wireless Mouse
- JU-PB-5000-W : 5,000 mAh Mini Size Promotional Powerbank



Gift Sets

Almost every business uses promotional products to please its clients with gifts.

GS-13

Promotional Gift Set #13

Contains total of 4 products as listed below;

- MPS-05-BK : Black Mobile Phone Stand
- PN42-BK : Black Metal Pen with Stylus
- USB-20-BK : Black Slide USB Flash Drive
- AF-001-BK : Black Flash Light



GS-14

Technology Gift Set #14

Contains total of 2 products as listed below;

- JU-WPB-8000 : 8,000 mAh Wireless Powerbank with Suction Cup
- USB-52 : Color Changing USB Flash Drive



We offer the Best and Ideal, Giveaways for Corporate events, business promotions & more.

Gift Sets

GS-15

Promotional Gift Set #07

Contains total of 3 products as listed below;

- JU-PB-5000-W** : 5,000 mAh Mini Size Promotional Powerbank
- PN26-W** : White Metal Pen with Stylus and LED light
- USB-20-W** : White Slide USB Flash Drive



GS-16

Promotional Gift Set #16

Contains total of 5 products as listed below;

- JU-WCP-1** : Promotional Wireless Charger
- PN26-W** : White Metal Pen with Stylus and LED light
- CARC-BK** : Promotional Car Charger



Gift Sets

Almost every business uses promotional products to please its clients with gifts.

GS-17



Promotional Gift Set #17

Contains total of 3 products as listed below;

- USB-20-W : White Slide USB Flash Drive
- JU-WM-W : Promotional Wireless Mouse
- JU-PB-5000-W : 5,000 mAh Mini Size Promotional Powerbank



GS-18



Promotional Gift Set #18

Contains total of 5 products as listed below;

- MB-06-BK : Black A6 Size PU Notebook
- PN27-BK : Metal Pen with Stylus
- BCH-02 : Business Card Holder
- AF-001-BK : Black Flash Light
- USB-TI-M : Aluminum Flash Card



We offer the Best and Ideal, Giveaways for Corporate events, business promotions & more.

Gift Sets

GS-19

Promotional Gift Set #19

Contains total of 3 products as listed below;

- MB-05-D** : Domiel Designs
A5 Size Notebook
- PN51-BK** : Domiel Designs
Black & Gold Metal Pen
- JU-WPB-10000** : 10,000 mAh Wireless
Powerbank with Suction Cup



GS-20

Travel Essentials Gift Set #20

Contains total of 4 products as listed below;

- DB-03** : Domiel Designs
Leather Passport Cover
- JU-TA-002-BK** : Promotional Travel Adaptor
018-W : Promotional Digital
Luggage Scale
- LUG-02-W** : Promotional Luggage Tag





AWARDS

PLAQUES &

TROPHIES

We offer a wide collection of Awards/Plaques

We offer different printing method such as;

Sublimation, Sandblasting, 2D/3D Laser Engraving
and Custom Made Cutting.



CR-27

Crystal Award

Available in 3 sizes
 (L) 15 x 22.5 x 5.7 cm
 (M) 15 x 20.5 x 5.7 cm
 (S) 15 x 18.5 x 5.7 cm
 Packing box included.
 Material : Cardboard

Printing Options : Laser Engraving,
 Sticker with sand blast effect



CR-15

Crystal Award

Available in 3 sizes
 (L) 21 x 35 cm
 (M) 18 x 28 cm
 (S) 15 x 26 cm
 Packing box included.
 Material : Wood

Printing Options : Laser Engraving,
 Sticker with sand blast effect



CR-09

Crystal Award

Award Specifications
 Material : Crystal
 Size : 16 x 23 cm
 Packing box included.
 Material : Wood

Printing Options : Laser Engraving,
 Sticker with sand blast effect



CR-07

Crystal Award

Available in 3 sizes
 (B) 18 x 20 cm
 (M) 15 x 17 cm
 (S) 10 x 12 cm
 Packing box included.
 Material : Cardboard

Printing Options : Laser Engraving,
 Sticker with sand blast effect





CR-04
Crystal Award

Award Specifications
Material : Crystal
Size : 18 x 24 cm

Packing box included.
Material : Wood
Size : 22.5 x 28 x 7 cm

Printing Options : Engraving, Sticker with sand blast effect



CR-12
Crystal Globe Award

Award Specifications
Material : Crystal & Metal
Size : 30 cm (height)
8 x 8 cm (base)

Packing box included.
Material : Wood
Size : 12 x 35 x 10 cm

Printing Options : Sublimation (Base)



CR-05
Crystal Award with wooden base

Product Specifications
Material : Crystal
Size : 13 x 19 cm

Packing box included.
Material : Wood

Printing Options : Engraving, Sticker with sand blast effect



CR-10
UAE Crystal Falcon

Crystal engraved with UAE falcon design. Promoting your message on the base in full color or laser markings.
Size : 24.3 x 16.3 cm

Packing box included.
Material : Wood

Printing Options : Sublimation (Base)



CR-13
Crystal Star Award

Award Specifications
Material : Crystal
Size : 27 cm (height)
8 x 8 cm (base)

Packing box included.
Material : Wood
Size : 13 x 31.5 x 11 cm

Printing Options : Sublimation (Base)



TR-03
UAE Falcon

3D falcon award made from metal with crystal base.
Size : 25 cm (height)
12 x 12 cm (base)

Packing box included.
Material : Hardboard

Printing Options : Sublimation (Base)



206

Crystal with 2 Rounded corner

Dimension : 150 x 100 mm

Printing Options : Laser Engraving



207

Semi-circle Crystal

Dimension : 157 x 76 mm

Printing Options : Laser Engraving



209

Rectangular Crystal

Dimension : 60 x 80 mm

Printing Options : Laser Engraving



210

Round Crystal

Dimension : 150 x 165 mm

Printing Options : Laser Engraving



211

Inclined Rectangular Crystal

Dimension : 60 x 80

Printing Options : Laser Engraving



212

Inclined Round Crystal

Dimension : 86 x 88 mm

Printing Options : Laser Engraving

Personalized Crystals

Engrave your Corporate Logo, Memorable Events or even your Personal photos



CRYSTALS FOR 2D/3D LASER ENGRAVING



CR-23

Cube Crystal

Size : 6 x 6 x 6 cm
Packing box included.



CR-24

Cube Crystal

Size : 8 x 8 x 8 cm
Packing box included.



CR-25

Rectangular Crystal

Size : 5 x 5 x 8 cm
Packing box included.



CR-26

Rectangular Crystal

Size : 6 x 8 x 12 cm
Packing box included.

**PROMOTE YOUR
CORPORATE LOGO
OR EVENTS**



**Packing Box
for Crystals**

LASER ENGRAVING SERVICE

Innovatively combining the world's most advanced high-resolution 2D / 3D laser engraving technology with exceptional artistry.



2D/3D

Laser engraving services using advance technology producing an awesome results for our clients, We are able to offer a unique result such as your memorable images or corporate logos inside a crystal, a memory that will last a life time.

- ➔ High Speed Engraving
- ➔ High Accuracy, Perfect Images
- ➔ Fast Production time

- ➔ Presentable output
- ➔ Applicable on other materials
- ➔ Affordable Prices



WPL-01

Plaques with Box

Shield shaped in gloss finish.
Packed in box with velvet
Plaque Size : 17 x 21 cm
Box Size : 19.5 x 23.5 cm

Printing Options : Sublimation



WPL-02

Plaques with Box

Shield shaped in gloss finish.
Packed in box with velvet
Plaque Size : 21.7 x 28.7 cm
Box Size : 24.5 x 31.5 cm

Printing Options : Sublimation

Landscape Wooden Plaques with Box for Sublimation Printing



WPL-05-H

Plaque Size :
30 x 23 cm
Box Size :
32.5 x 25 cm



WPL-04-H

Plaque Size :
25.5 x 20 cm
Box Size :
28 x 22.5 cm



WPL-03-H

Plaque Size :
20 x 15 cm
Box Size :
22.5 x 17.5 cm



Portrait Wooden Plaques with Box for Sublimation Printing



WPL-03-V

Plaque Size :
20 x 15 cm
Box Size :
22.5 x 17.5 cm



WPL-04-V

Plaque Size :
25.5 x 20 cm
Box Size :
28 x 22.5 cm



WPL-05-V

Plaque Size :
23 x 30 cm
Box Size :
25 x 32.5 cm



1211-A

Wooden Plaques

Rectangular shaped with high gloss finish.
Solid wood material
Size : 30.5 x 38 cm

1211-C

Wooden Plaques

Rectangular shaped with high gloss finish.
Solid wood material
Size : 20.5 x 25.5 cm



1248-S-P

Wooden Plaques with Spanish plate

Rectangular shaped with high gloss finish.
Wood material & silver designed plate
Size : 30.5 x 23 cm



1241-BG

Wooden Plaques with Spanish plate

Rectangular with high gloss finish.
Wood material & gold designed plate
Size : 20 x 25.5 cm



1240-BS

Wooden Plaques with Spanish plate

Rectangular shaped with high gloss finish.
Wood material & silver designed plate
Size : 20 x 25.5 cm



AG-P



AS-P

1243

Wooden Plaques with Spanish plate

Rectangular shaped with high gloss finish.
Wood material & gold/silver designed plate
Size : 23 x 30.5 cm



AG-P



AS-P

1242

Wooden Plaques with Spanish plate

Rectangular shaped with high gloss finish.
Solid wood material & gold designed plate
Size : 23 x 30.5 cm

Oval Metal Badges

Promote your Logo / Brand by Full Color Printing with Epoxy

- 2043-G : 47 x 31 mm
- 2042-G : 37 x 26 mm
- 2041-G : 28 x 20 mm
- 2040-G : 22 x 15 mm

Gold Oval Rope Design Badges

Material : Metal
Available in 4 different sizes.



- 2043-N : 47 x 31 mm
- 2042-N : 37 x 26 mm
- 2041-N : 28 x 20 mm
- 2040-N : 22 x 15 mm

Silver Oval Rope Design Badges

Material : Metal
Available in 4 different sizes.



- 2043-B : 47 x 31 mm
- 2042-B : 37 x 26 mm
- 2041-B : 28 x 20 mm
- 2040-B : 22 x 15 mm

Bronze Oval Rope Design Badges

Material : Metal
Available in 4 different sizes.



BACKSIDE OPTIONS



Pin



Butterfly Clutch



Magnet

Round Metal Badges

Promote your Logo / Brand by Full Color Printing with Epoxy



- 2048-G : 47 mm
- 2047-G : 37 mm
- 2046-G : 27 mm
- 2045-G : 22 mm
- 2044-G : 13 mm

Gold Round Rope Design Badges

Material : Metal
Available in 5 different sizes.



- 2048-N : 47 mm
- 2047-N : 37 mm
- 2046-N : 27 mm
- 2045-N : 22 mm
- 2044-N : 13 mm

Silver Round Rope Design Badges

Material : Metal
Available in 5 different sizes.



- 2047-B : 37 mm
- 2046-B : 27 mm
- 2044-B : 13 mm

Bronze Round Rope Design Badges

Material : Metal
Available in 3 different sizes.

BACKSIDE OPTIONS



Pin



Butterfly Clutch



Magnet

Promotional Flat Metal Badges

Promote your Logo / Brand by Full Color Printing with Epoxy

- 2029-G** : 45 x 20 mm
- 2028-G** : 35 x 15 mm
- 2027-G** : 25 x 15 mm
- 2033-G** : 25 x 18 mm

Gold Oval Flat Badges

Material : Metal
Available in 4 different sizes.

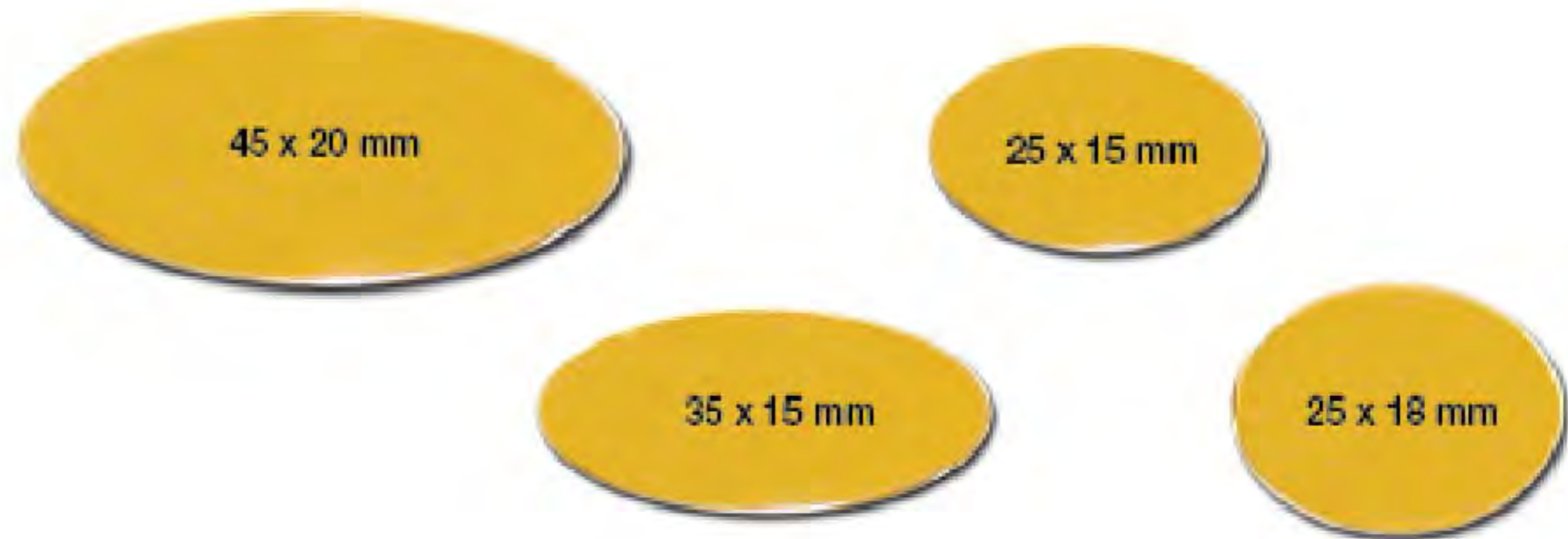

- 2029-N** : 45 x 20 mm
- 2028-N** : 35 x 15 mm
- 2027-N** : 25 x 15 mm
- 2033-N** : 25 x 18 mm

Silver Oval Flat Badges

Material : Metal
Available in 4 different sizes.



Pin



Butterfly Clutch



Magnet

- 2030-22G** : 22 mm
- 2030-18G** : 18 mm

Gold Square Flat Badges

Material : Metal
Available in 2 sizes.



- 2030-22N** : 22 mm
- 2030-18N** : 18 mm

Silver Square Flat Badges

Material : Metal
Available in 2 sizes.



- 2031-G** : Gold Badge
- 2031-N** : Silver Badge

Gold / Silver Rectangular Flat Badges

Material : Metal
Size : 30 x 17 mm



Round Flat Metal Badges

Promote your Logo / Brand by Full Color Printing with Epoxy

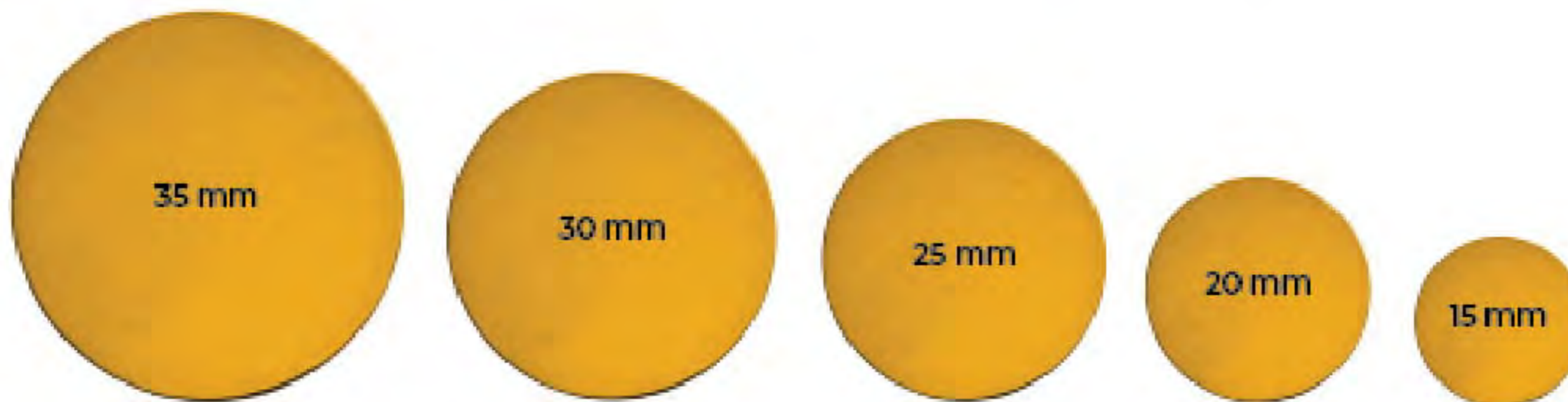

- 2026-G :** 35 mm
- 2083-G :** 30 mm
- 2025-G :** 25 mm
- 2024-G :** 20 mm
- 2034-G :** 15 mm

Gold Flat Badges

Material : Metal
Available in 5 different sizes.



- 2025-N :** 25 mm
- 2024-N :** 20 mm
- 2034-N :** 15 mm

Silver Flat Badges

Material : Metal
Available in 5 different sizes.



2026-SS

Shiny Silver Flat Badges

Material : Metal
Size : 35 mm



2083-SS

Shiny Silver Flat Badges

Material : Metal
Size : 30 mm



Butterfly Clutch



Magnet



Pin



2039-G

Material : Metal | Size : 35 mm



2039-G

Material : Metal | Size : 35 mm



2039-N

Material : Metal | Size : 35 mm



2038-G

Material : Metal | Size : 25 mm



2038-G

Material : Metal | Size : 25 mm



2038-N

Material : Metal | Size : 25 mm



2037-G

Material : Metal | Size : 20 mm



2037-G

Material : Metal | Size : 20 mm



2037-N

Material : Metal | Size : 20 mm



2049-G

**Gold
Metal Badges**

Material : Metal
Size : 30 x 30 mm



2049-N

**Silver
Metal Badges**

Material : Metal
Size : 30 x 30 mm



2053-N

**Silver
Metal Badges**

Material : Metal
Size : 25 x 25 mm

Lapel Pin

Promote your Logo / Brand
by Full Color Printing with Epoxy



2010-N

2011-N

2012-N

2013-N



2010-G

2013-G

2014-G

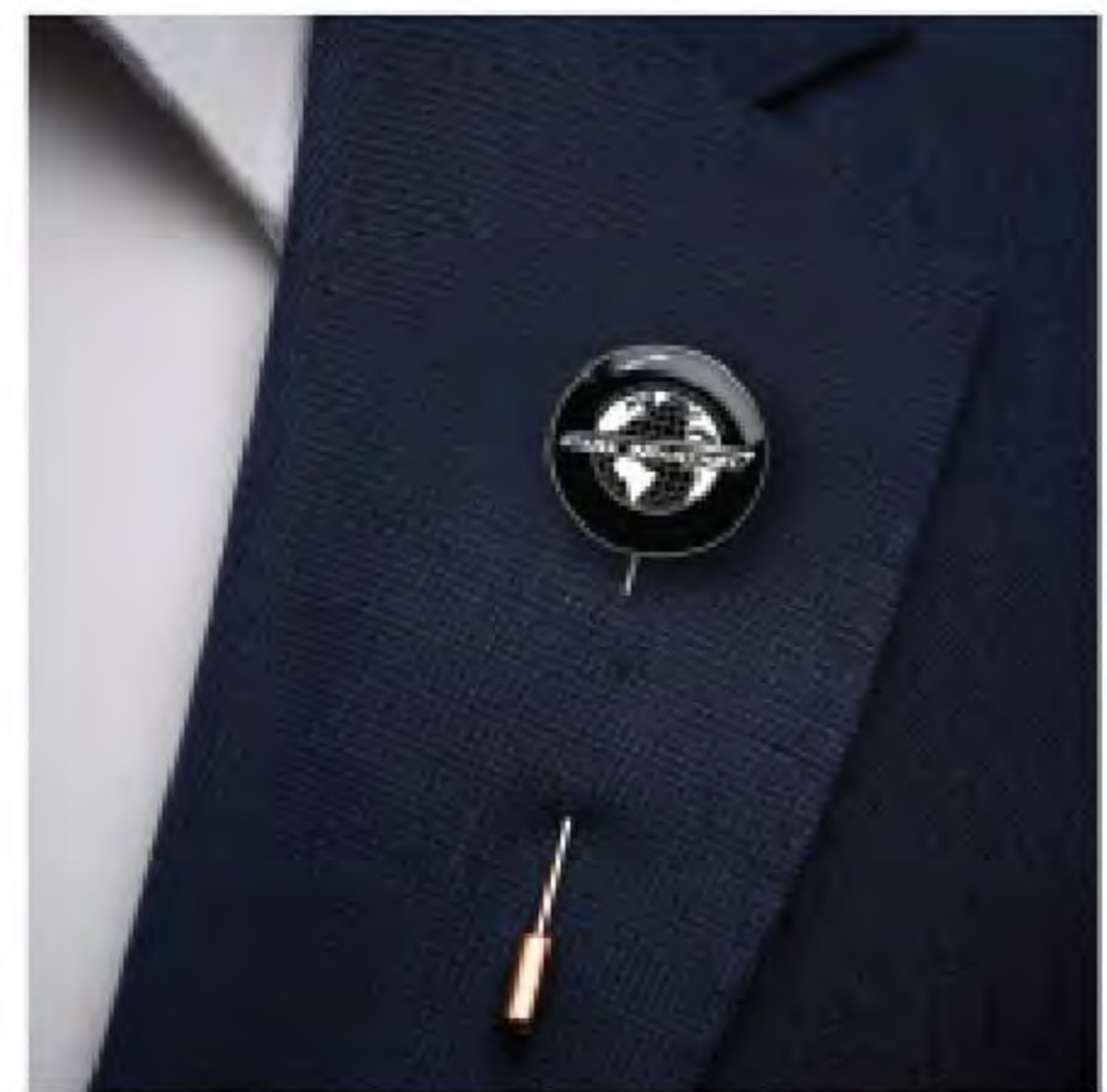

MCL-1

Promotional Metal Cufflinks

Material : Stainless Steel
Size : 19 x 19 mm dia.

- Printing Options:
- Full Color with Epoxy
 - Laser Markings





2073

Promotional Tie Pin

Gold plated pin for tie
Product Size : 60 x 8 mm

Printing Options :
• Full color with epoxy



2017

Promotional Tie Pin with Round Logo Area

Gold plated pin for tie
Product Size : 55 x 20 mm

Printing Options :
• Full color with epoxy



2101

Dubai Metal Badge

Debossed with colour filing.
Product Size : 50 x 21 mm
Thickness : 1 mm
Backside with Magnet

2095

Promotional Pink Ribbon Metal Badge

Mostly used on breast cancer awareness month.
Size : 15 x 25 mm



2114-WP

Smiley Badges

Material : Metal
Size : 30 mm
Backside with Pin

2114-A

Smiley Badges

Material : Metal
Size : 30 mm
Backside with Magnet





NDB-22
**National Day Badge with
 Sheikh Zayed Picture**

Backside with Magnet
 Size : 30 x 30 mm



NDB-23
**National Day Badge with
 Year of Tolerance Logo**

Backside with Magnet
 Size : 30 x 30 mm



2102
UAE Peace Sign Badge

Backside with Magnet
 Size : 28 x 35 mm



NDB-16
UAE Flag Metal Badge

Backside with Magnet
 Size : 30 x 30 mm



NDB-17
UAE Metal Badge

Backside with Magnet
 Size : 40 x 30 mm



NDB-07G
UAE Metal Badge

Backside with Magnet
 Size : 34 x 24 x 1.6 mm



NDB-07N
UAE Metal Badge

Backside with Magnet
 Size : 34 x 24 x 1.6 mm



NDB-05N
UAE Metal Badge

Backside with Magnet
 Size : 45 x 30 x 1.5 mm



NDB-18
Flag Ribbon Metal Badge

Backside with Magnet
 Size : 28 x 45 mm



2094-N-UAE / 2094-G-UAE
UAE Metal Badge

Backside with Pin
 Size : 25 x 35 mm



2094-G-WM
UAE Metal Badge

Backside with Magnet
 Size : 25 x 35 mm

2082-G

I Love Badges

Material : Metal
Size : 30 x 20 mm
Backside with Pin



2082-N

I Love Badges

Material : Metal
Size : 30 x 20 mm
Backside with Pin



2100-1

UAE Falcon Metal Badge

Material : Metal
Size : 25 x 30 mm
Backside with Magnet
(Embossed Design)



2094-N



2094-G

2100-2

UAE Falcon Metal Badge

Material : Metal
Size : 25 x 30 mm
Backside with Magnet
(Debossed Design)



Backside with Butterfly Clutch



Backside with Magnet

Flag Metal Badge

Material : Metal
Size : 35 x 25 mm

2092

UAE Flag Metal Badge

Material : Metal
Size : 20 x 15 mm
Available in 2 options.



Butterfly clutch



Magnet

2091

Flag Metal Badge

Material : Metal
Size : 20 x 15 mm





NDB-21

UAE Flag Metal Badge

Material : Metal
 Size : 35 x 20 mm
 Backside with Magnet



2081

Two Flag Metal Badge

Material : Metal
 Size : 35 x 25 mm
 Backside with Butterfly clutch

2106

Heart Shaped Pin Badge

Material : Metal
 Size : 30 x 32 mm

- Available in 2 options.
- Backside with Pin
 - Backside with Magnet



2080

Flag & Medal Gold Badge

Material : Metal
 Medal Size : 42 mm
 Flag Size : 42 x 25 mm
 Backside with Pin



2079

UAE Flag & Medal Gold Badge

Material : Metal
 Medal Size : 42 mm
 Flag Size : 42 x 25 mm
 Backside with Pin

Promotional Medals

Promote your Logo by Full Color Printing with Epoxy



Front Side



Back Side

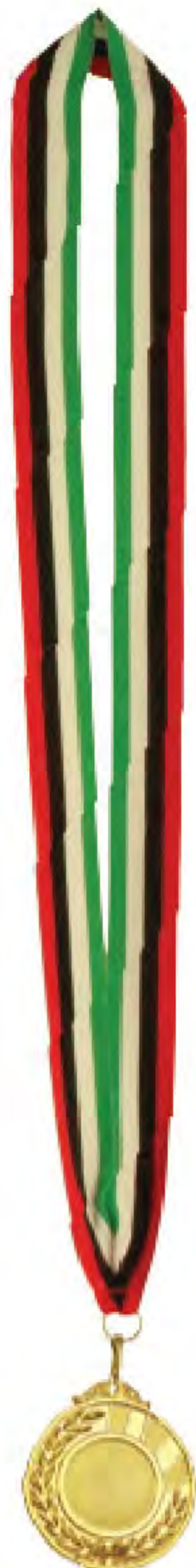

2065-G

65mm Gold Medal

Material : Metal (Gold finish)
Includes Ribbon (White / UAE)
Flag Ribbon optional
Size : 65 mm



2065-N

65mm Silver Medal

Material : Metal (Silver finish)
Includes Ribbon (White / UAE)
Flag Ribbon optional
Size : 65 mm



2065-B

65mm Bronze Medal

Material : Metal (Bronze finish)
Includes Ribbon (White / UAE)
Flag Ribbon optional
Size : 65 mm

Options Ribbons



2065-RW
Full White



2065R-UAE
UAE Flag



2065R-OM
OMAN Flag



2065R-BH
BAHRAIN Flag



2065R-KSA
KSA Flag



2064-G

50m Gold Medal

Material : Metal (Gold finish)
Includes Ribbon (White / UAE)
Flag Ribbon optional
Size : 50 mm

2064-N

50m Silver Medal

Material : Metal (Silver finish)
Includes Ribbon (White / UAE)
Flag Ribbon optional
Size : 50 mm

2064-B

50m Bronze Medal

Material : Metal (Bronze finish)
Includes Ribbon (White / UAE)
Flag Ribbon optional
Size : 50 mm



2055

Medal Pin Badge

Material : Metal
Medal Size : 45 mm
Backside with Pin



2084-N

Silver Plated Pin Medals

Material : Metal
Round Area : 55 mm
Top Area : 50 x 15 mm
Backside with Pin

Pins, Badges & Medal Boxes



267-PPB-B

Pin / Badge Packing Box

Material : Plastic with Foam
Size : 70 x 70 x 18 mm



267-PPB-S

Pin / Badge Packing Box

Material : Plastic with Velvet
Size : 55 x 40 x 22 mm



267-MB

Pin / Badge Packing Box

Material : Plastic with Velvet
Size : 40 x 40 mm



267-PB

Plastic Medal Box

Material : Plastic with Velvet
Size : 85 x 115 x 15 mm



267-PS

Plastic Medal Box

Material : Plastic with Velvet
Size : 75 x 105 x 15 mm



267-V

Presentation Medal Box

Material : Velvet



Plastic Reusable Window Insert

Name Badges



2032-G

Full Size : 68 x 33 mm
Window Size : 63 x 13 mm
Matte Gold Finish

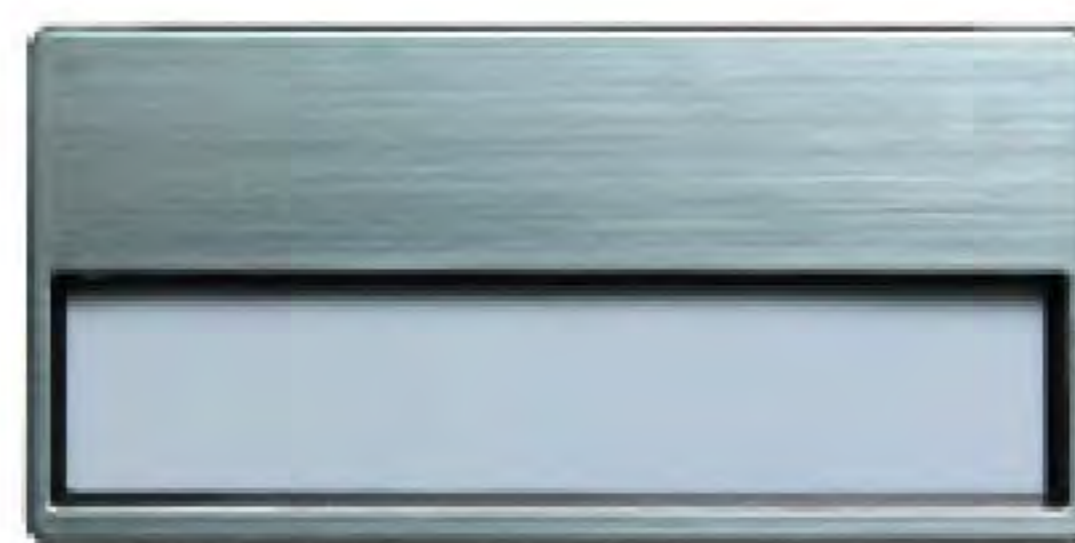

2032-N

Full Size : 68 x 33 mm
Window Size : 63 x 13 mm
Matte Silver Finish



2032-W

Full Size : 68 x 33 mm
Window Size : 63 x 13 mm
White Plastic



Backside with Clip & Pin



Backside with Clip, Pin & Magnet

**Reusable
Ready-made
Badges**



INB-7001

Reusable Name Badge

Size : 78 x 32 mm | Backside with Magnet



INB-7000

Reusable Name Badge

Size : 65 x 30 mm | Backside with Magnet

Reusable Window Insert Name Badges for Sublimation



Backside



Area for pin or magnet attachment



INB-05W

Full Size : 73 x 38 mm
Window Size : 63 x 12 mm



INB-05N

Full Size : 73 x 38 mm
Window Size : 63 x 12 mm



INB-05G

Full Size : 73 x 38 mm
Window Size : 63 x 12 mm





INB-12-W



INB-12-N



INB-12-G

INB-12

Reusable Name Badge

Full Size : 80 x 30 mm | Plate Size : 76 x 26 mm
3 optional sublimation plate

Printing Options :
• Full color Sublimation

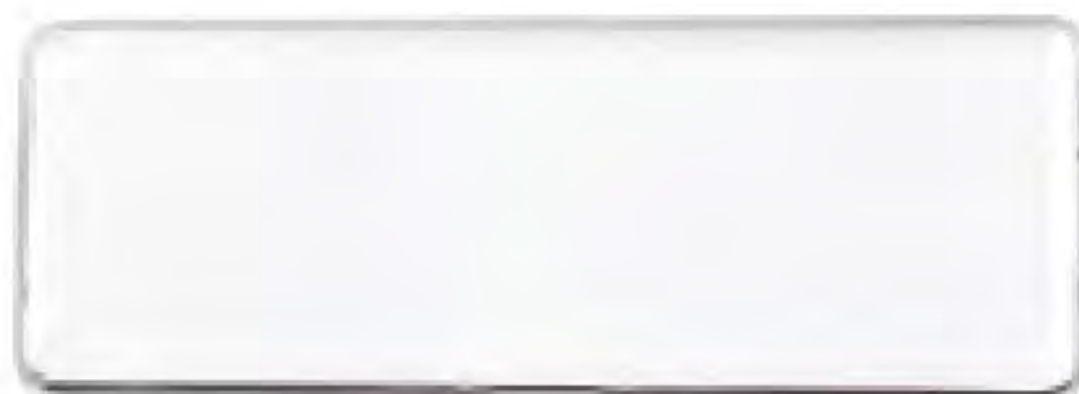

INB-03-W

Lens Cover Rectangular White Name Badges

Size : 80 x 30 mm
Backside with pin or magnet
Printing Options : Sublimation



INB-03-N

Lens Cover Rectangular Silver Name Badges

Size : 80 x 30 mm
Backside with pin or magnet
Printing Options : Sublimation



INB-03-G

Lens Cover Rectangular Gold Name Badges

Size : 80 x 30 mm
Backside with pin or magnet
Printing Options : Sublimation



NAME BADGES



INB-08-W

**Lens Cover Rectangular
White Name Badges**

Size : 80 x 40 mm
Backside with pin or magnet
Printing Options : Sublimation



INB-08-N

**Lens Cover Rectangular
White Name Badges**

Size : 80 x 40 mm
Backside with pin or magnet
Printing Options : Sublimation



INB-08-G

**Lens Cover Rectangular
White Name Badges**

Size : 80 x 40 mm
Backside with pin or magnet
Printing Options : Sublimation

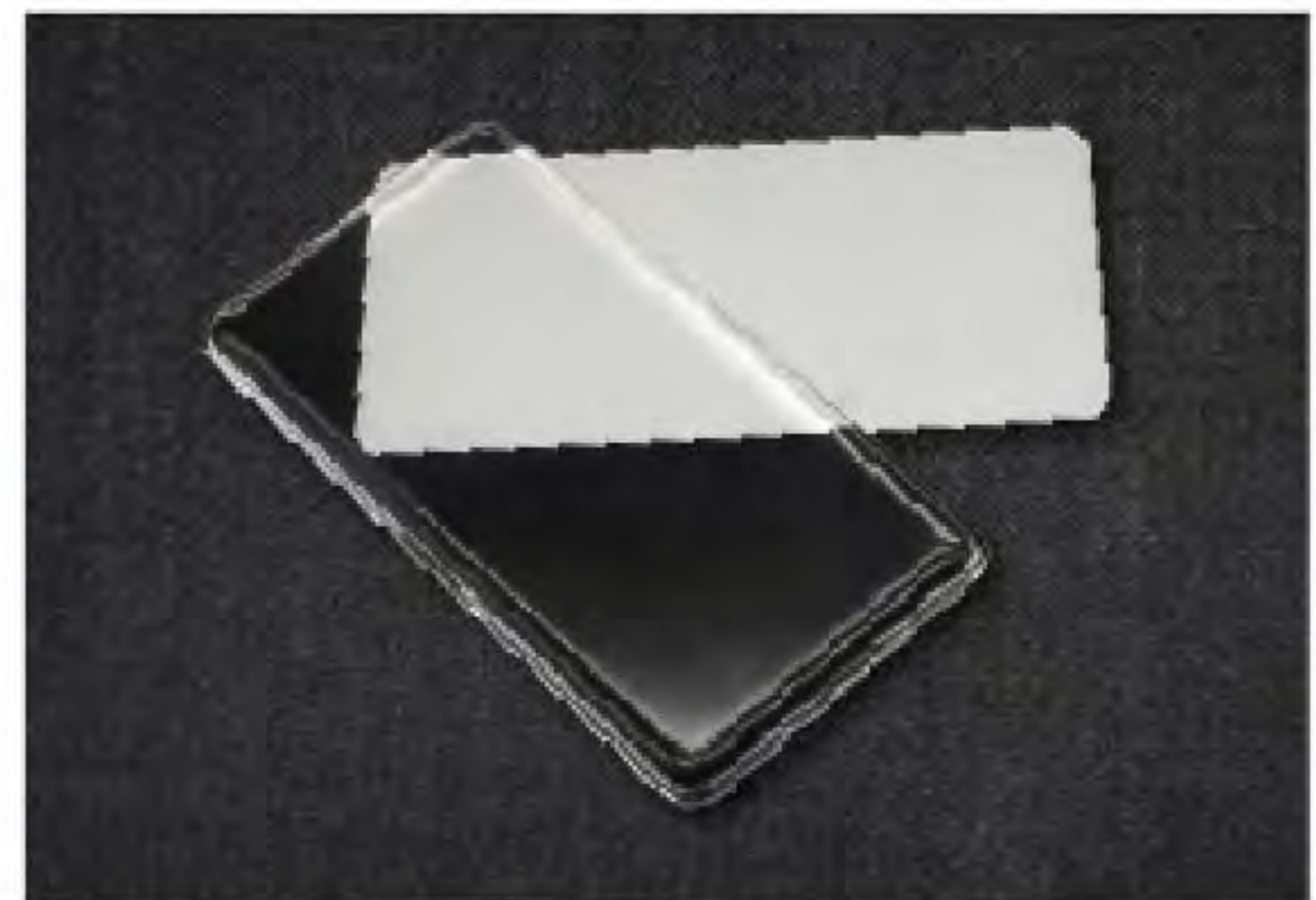

INB-09-W

**Lens Cover Oval
White Name Badges**

Size : 68 x 45 mm
Backside with pin or magnet
Printing Options : Sublimation



INB-09-N

**Lens Cover Oval
Silver Name Badges**

Size : 68 x 45 mm
Backside with pin or magnet
Printing Options : Sublimation



INB-09-G

**Lens Cover Oval
Gold Name Badges**

Size : 68 x 45 mm
Backside with pin or magnet
Printing Options : Sublimation





INB-07

Reusable Acrylic Name Badge

Material : Acrylic
Big Size : 50 x 40 mm
Backside with Clip & Pin

INB-04

Reusable Acrylic Name Badge

Material : Acrylic
Big Size : 75 x 40 mm
Backside with Magnet or Pin



INB-02

Reusable Acrylic Name Badge

Material : Acrylic
Small Size : 70 x 25 mm
Backside with Magnet or Pin

INB-06

Reusable Acrylic Name Badge

Material : Acrylic
Big Size : 75 x 20 mm
Backside with Magnet or Pin





2076-G

Gold Reusable Metal Name Badge

Material : Metal
Size : 70 x 40 mm
Backside with Magnet



2076-N

Silver Reusable Metal Name Badge

Material : Metal
Size : 70 x 40 mm
Backside with Magnet



2023-G

Shiny Gold Plated Metal Name Badges

Material : Metal
Size : 75 x 25 mm
Backside with Pin (Magnet Optional)



2023-N

Shiny Silver Metal Name Badges

Material : Metal
Size : 75 x 25 mm
Backside with Pin (Magnet Optional)



2088-N

Two Tone Name Badge

Matte Silver with Shiny Edges
Material : Metal
Size : 68 x 17 mm
Backside with Magnet



2063-N

Metal Injected Name Badges

Silver Metal Badges suitable for inserting the full color Printing & Epoxy sticker or sublimation aluminium plate.

Material : Metal
Size : 78 x 27 mm
Backside with Pin (Magnet Optional)

2062

PVC Injected Name Badges

Plastic Badges suitable for inserting the full color Printing & Epoxy sticker.

Material : PVC
Size : 80 x 25 mm

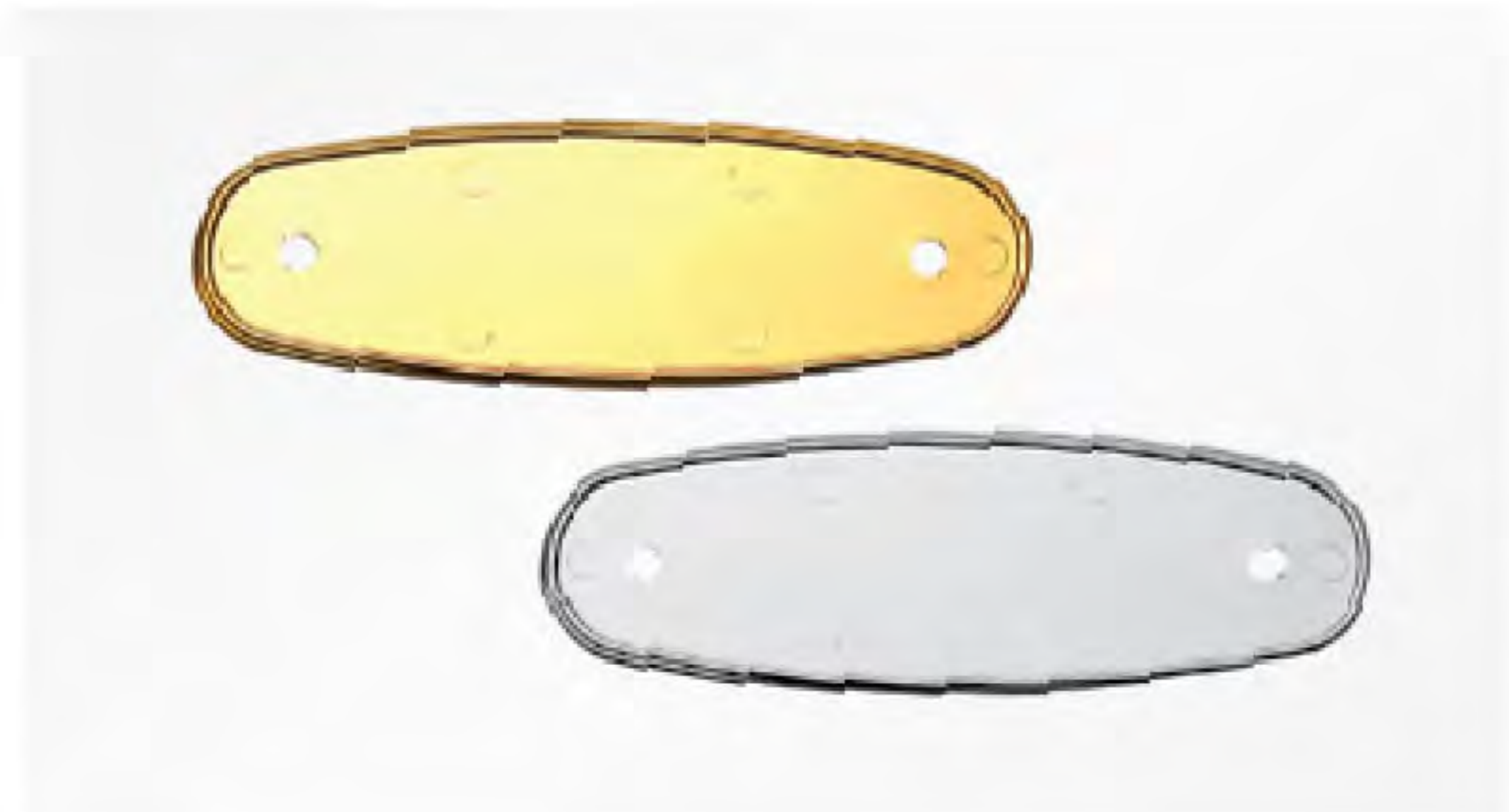

2056-G : 50 mm
2058-G : 30 mm

PVC Injected Name Badges

Plastic Badges suitable for inserting the full color Printing & Epoxy sticker.

Material : PVC
Available in 2 sizes
Backside with Magnet



2059-G
Gold Colour
70 x 35 mm



2059-N
Silver Colour
70 x 35 mm



2060-G
Gold Colour
60 x 30 mm



2060-N
Silver Colour
60 x 30 mm



2061-G
Gold Colour
40 x 20 mm



2061-N
Silver Colour
40 x 20 mm





2087-N

Metal Injected Name Badges

Silver Metal Badges suitable for inserting the full color Printing & Epoxy sticker or sublimation aluminium plate.

Material : Metal
 Size : 72 x 21 mm
 Backside with Pin (Magnet Optional)



2087-G

Metal Injected Name Badges

Gold Metal Badges suitable for inserting the full color Printing & Epoxy sticker or sublimation aluminium plate.

Material : Metal
 Size : 72 x 21 mm
 Backside with Pin (Magnet Optional)

Metal Name Badges for Full color with Epoxy



2019-G
 Matt Gold
 75 x 25 mm



2022-SMG
 Matt Gold
 68 x 17 mm



2022-BSG
 Shiny Gold
 75 x 25 mm



2022-SSG
 Shiny Gold
 68 x 17 mm



2019-N
 Matt Silver
 75 x 25 mm



2022-SMN
 Matt Silver
 68 x 17 mm



2022-BSN
 Shiny Silver
 75 x 25 mm



2022-SSN
 Shiny Silver
 68 x 17 mm

Engravable PVC Name Badges (suitable for Laser Engraving to reveal the underneath colour)



2021BMG-BK

Matt Gold / Black
Size : 75 x 25 mm

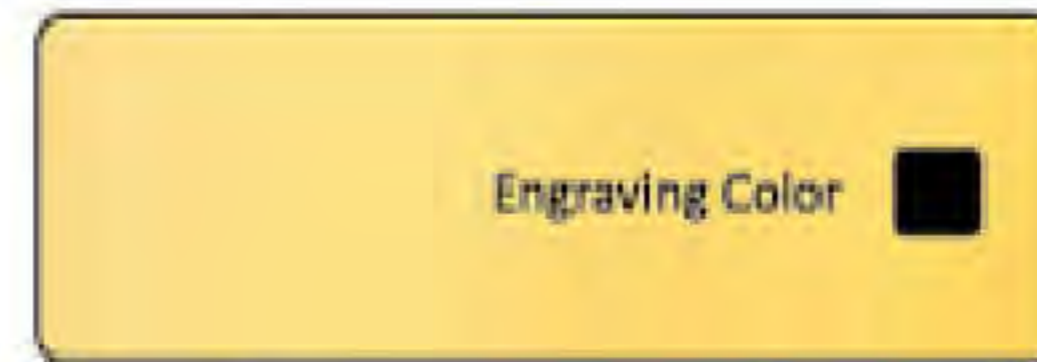

2021BSG-BK

Shiny Gold / Black
Size : 75 x 25 mm



2021SMG-BK

Matt Gold / Black
Size : 68 x 17 mm



2021SSG-BK

Shiny Gold / Black
Size : 68 x 17 mm



2021BMS-BK

Matt Silver / Black
Size : 75 x 25 mm

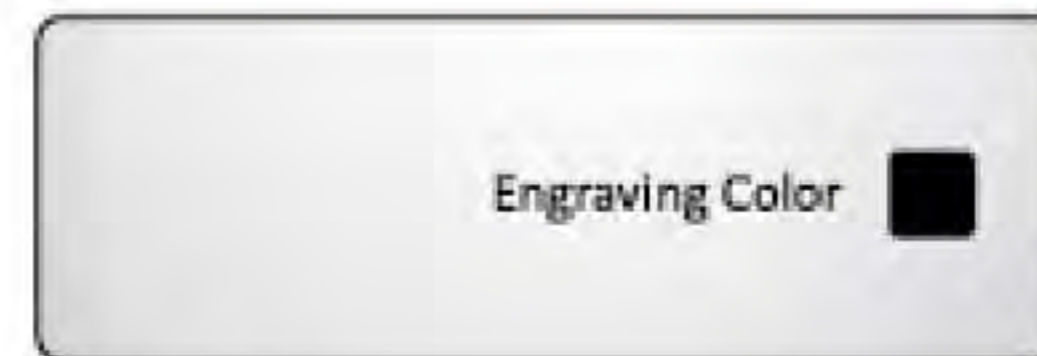

2021BSS-BK

Shiny Silver / Black
Size : 75 x 25 mm



2021SMS-BK

Matt Silver / Black
Size : 68 x 17 mm

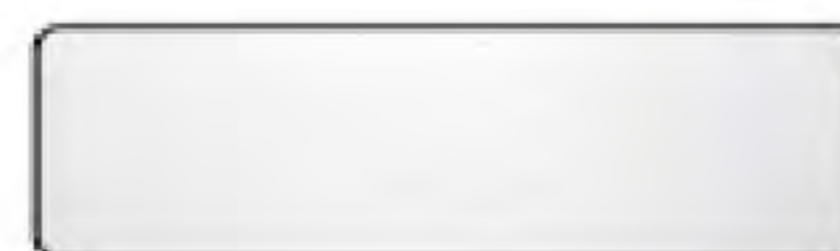

2021SSS-BK

Shiny Silver / Black
Size : 68 x 17 mm



2021BW-R

White / Red
Size : 75 x 25 mm



2021BW-GR

White / Green
Size : 75 x 25 mm



2021SW-R

White / Red
Size : 68 x 17 mm



2021SW-GR

White / Green
Size : 68 x 17 mm



2021BW-BK

White / Black
Size : 75 x 25 mm



2021BY-BK

Yellow / Black
Size : 75 x 25 mm



2021SW-BK

White / Black
Size : 68 x 17 mm



2021SY-BK

Yellow / Black
Size : 68 x 17 mm



2021BBL-W

Blue / White
Size : 75 x 25 mm



2021BR-W

Red / White
Size : 75 x 25 mm



2021SBL-W

Blue / White
Size : 68 x 17 mm



2021SR-W

Red / White
Size : 68 x 17 mm

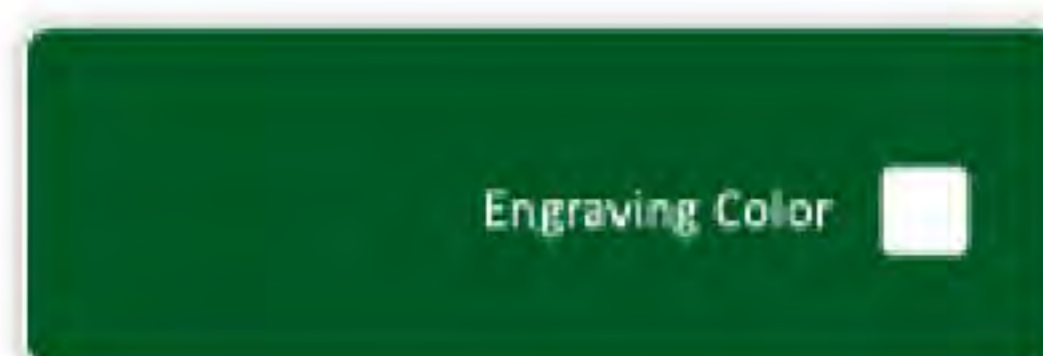

2021BGR-W

Green / White
Size : 75 x 25 mm

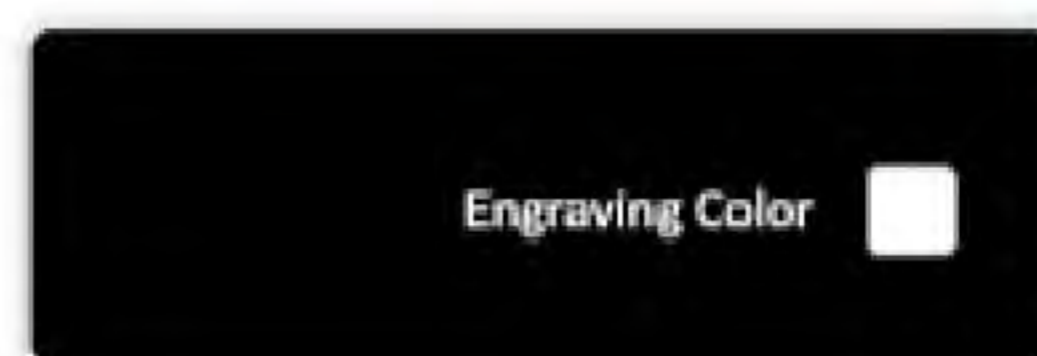

2021BBK-W

Black / White
Size : 75 x 25 mm



2021SGR-W

Green / White
Size : 68 x 17 mm

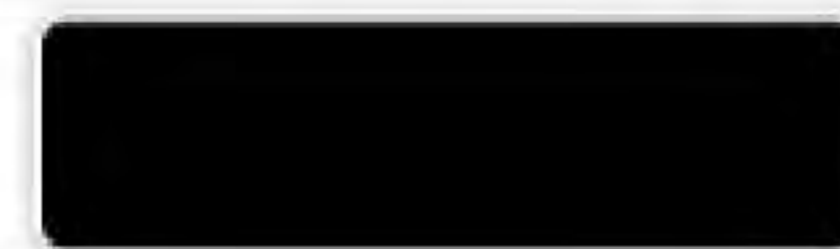

2021SBK-W

Black / White
Size : 68 x 17 mm

PINS & MAGNETS ATTACHMENTS



2016-C
Size : 45 x 13 mm
Magnet accessories



2016-J
Size : 45 x 13 mm
Magnet accessories



2016-D
Size : 33 x 13 mm
Magnet accessories



2016-A
Size : 45 x 13 mm
Magnet accessories



2016-B
Size : 18 mm
Magnet accessories



2016-K
Size : 30 mm
Magnet accessories



2016-N : 15 mm
2016-H : 8 mm
Available in 2 sizes
Magnet accessories



2016-M
Size : 50 x 20 mm
Magnet accessories



2016-O
Small Rectangular
Magnet accessories



2015-32
Size : 32 mm
Pins with or without 3m Tape



2015-38
Size : 38 mm
Pins with or without 3m Tape



2015-50
Size : 50 mm
Pins with or without 3m Tape



2015-G
Size : 10 mm
Gold Butterfly Clutch



2015-S
Size : 10 mm
Silver Butterfly Clutch



2015-N
Size : 10 mm
Gold/Transparent Butterfly Clutch



2015-P
Size : 55 mm
Pin accessories



2015-Q
Size : 40 mm
Pin accessories



2015-M
Size : 50 x 10 mm
Backside Pin



2015-A
Size : 7 x 20 mm
Clip accessories



2015-K
Size : 38 x 5 mm
Pin accessories



2015-H
Size : 38 mm
Pin accessories



2015-B
Size : 15 x 20 mm
Clip with Pin accessories



2015-C
Size : 13 x 20 mm
Clip with Pin accessories



2015-D
Size : 15 x 25 mm
Clip with Pin accessories



2015-I
Size : 30 mm
Pins with or without Tape



2015-F
Size : 45 mm
Pins with or without Tape



2015-E
Size : 45 mm
Pins with or without Tape



LANYARDS

REEL BADGES &

ID CARD HOLDERS

Your Biggest Supplier for ID Solutions.

We offer large selection of lanyards, Reel Badges
& ID Card holders, We also offer
Custom-Made Lanyards.

LN-011

15mm Lanyard with Crocodile Hook, Safety Lock & Mobile Holder

Polyester material for screen printing



Printing Options :
• Screen Printing
• Sublimation (White)



LN-003

20mm Lanyard with Safety Hook & Buckle

Polyester material for screen printing



Printing Options :
• Screen Printing
• Sublimation (White)



LN-013

15mm Lanyard with Crocodile Hook & Mobile Holder

17mm Round Area for Full color with epoxy
Polyester material for screen printing



Printing Options :
• Screen Printing
• Sublimation (White)



LN-008

20mm Lanyard with Crocodile Hook & Mobile Holder

20mm Round Area for Full color with epoxy
Polyester material for Screen Printing



Printing Options :
• Screen Printing
• Sublimation (White)



Double Hook Lanyards

A great lanyard for exhibits, seminars & other corporate events.



LN-007-W

White Lanyard with Double hook

20mm Soft polyester material
for your full colour printing.

Printing Options : Sublimation



Sublimation Lanyards



The custom printed lanyards are your perfect choice to display your Design or Logo in full colour. They are printed on smooth polyester material through digital dye sublimation on one or two side printing.

20mm Lanyard with Buckle



LN-002
-CW

Clip Type
2 x 90 cm

LN-002
-HW

Hook Type
2 x 90 cm

20mm Lanyard w/Safety Hook



LN-004
-CW

Clip & Mobile Holder
2 x 90 cm

LN-004
-HW

Hook & Mobile Holder
2 x 90 cm

15mm Standard Lanyard



LN-005
-CW

Clip & Mobile Holder
1.5 x 90 cm

125

Round Shaped Reel Badge

Plastic reel badge with slide-type clip and clear strap for ID.
Product Size : 32mm (dia.)

Printing Options : Full color printing with epoxy



126

Square Shaped Reel Badge

Plastic reel badge with slide-type clip and clear strap for ID.
Product Size : 32 x 32 mm

Printing Options : Full color printing with epoxy





127

Carablner Reel Badge

Carabiner with slide-type clip and clear strap for ID.

Printing Options : Full color printing with epoxy



128

Round Shaped Reel Badge

Plastic reel badge with slide-type belt clip and clear strap for ID.

Product Size : 32 mm (dia.)

Printing Options : Full color printing with epoxy





123

Rotating Reel Badge

Plastic reel badge with clear strap for ID.
Product Size : 32mm (dia.)

Printing Options : Full color printing with epoxy



Promotional Metal Reel Badges

More durable version of our round reel badges.
Perfect for both your outdoor / indoor purposes.



124-G

Gold Reel Badge

Metal reel badge with
slide-type clip and clear strap.
Product Size : 32 mm (dia.)

124-S

Silver Reel Badge

Metal reel badge with
slide-type clip and clear strap.
Product Size : 32 mm (dia.)

Protect your ID Cards with our Card Holders.

Using an ID holder will give your cards more protection from wear and tear, and allow you to easily reuse holders and accessories for new cardholders.

271-H
Clear Plastic ID Card Holder
For Horizontal ID cards
Size : 115 x 105 mm



272
Clear Plastic ID Card Holder
For Vertical ID cards
Size : 112 x 174 mm



268-V
Rigid semi-matte
PVC Card Holder

For Vertical ID cards
Size : 58 x 90 mm

268-H
Rigid semi-matte
PVC Card Holder

For Horizontal ID cards
Size : 85 x 62 mm



269-V
Semi-flexible matte
PVC Card Holder

For Vertical ID cards
Size : 58 x 90 mm

269-H
Semi-flexible matte
PVC Card Holder

For Horizontal ID cards
Size : 90 x 58 mm

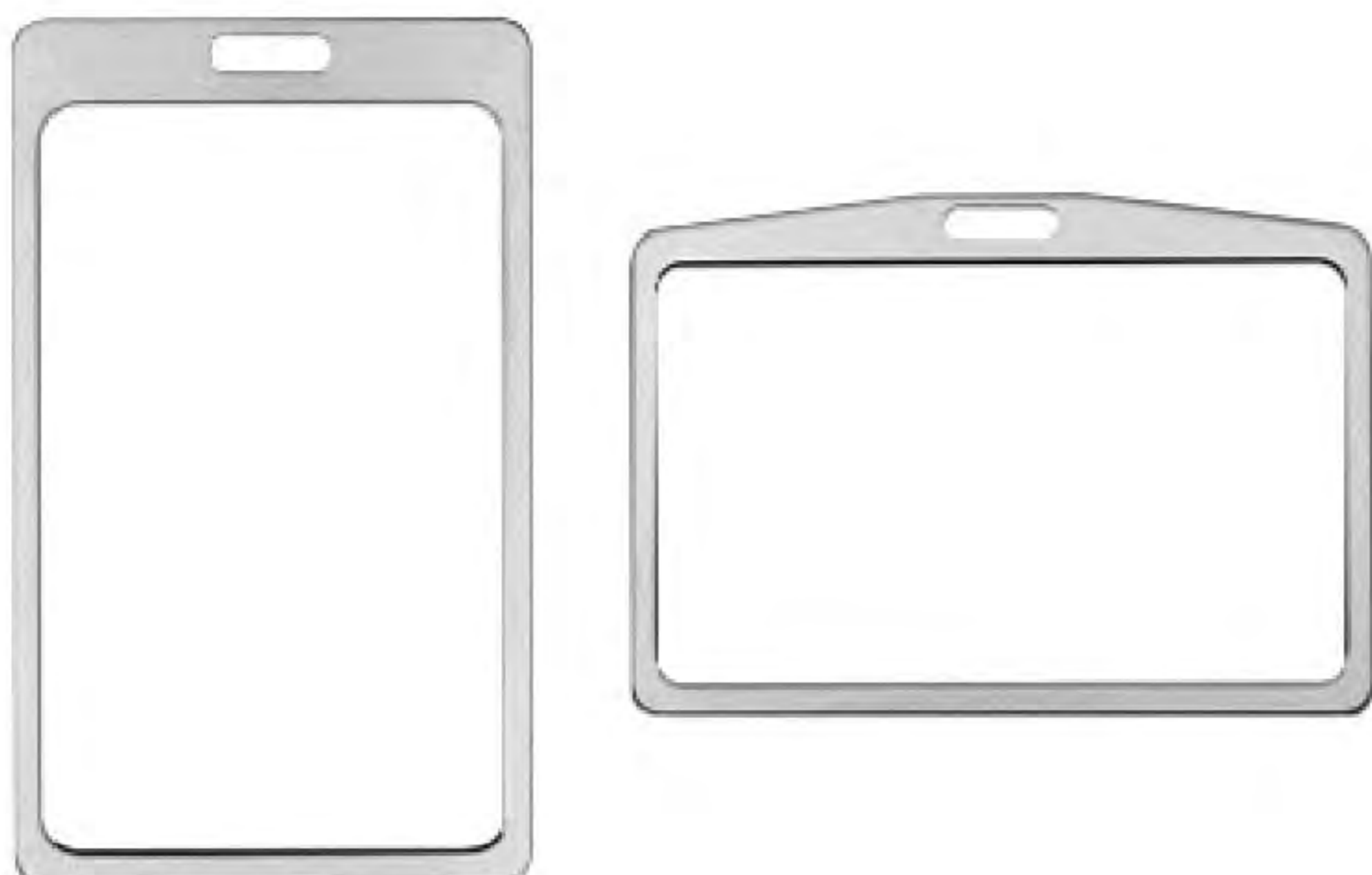

CH-004-V
Aluminum
ID Card Holder

For Vertical ID cards
Size : 60 x 98 mm

CH-004-H
Aluminum
ID Card Holder

For Horizontal ID cards
Size : 92 x 64 mm

Double Orientation ID Card Holder

ID Card Holder for Both Vertical or Horizontal Position.



CH-003

1 Side Rigid Full Clear PVC Card Holder

For Both Vertical & Horizontal
Size : 95 x 65 mm



269

1 Side Semi-flexible matte PVC Card Holder

For Both Vertical & Horizontal
Size : 95 x 65 mm

CH-002
2 Sided
PVC Card Holder
For Both Vertical & Horizontal
Size : 95 x 65 mm





Sublimation Solutions

Dye sublimation is a digital printing technology that enables the reproduction of colourful images on common everyday items, including clothing and novelties.

You create an image on your computer, print it onto a special transfer paper using sublimation inks, and then apply the paper with the image to the item to be decorated.

We offer a large collection of Blank Products that you can use for your Sublimation Projects.

146N
White Sublimation Mug with Silicone Cap & Base

Ceramic mug with a heart shaped handle & matching color of silicone cap to avoid leaks & non-slip silicone base.
Dimensions : † 125 mm Ø 85 mm

BK
BL
GR
OR
R

White mug is the most popular choice among products made for personalization. Coated with Orca 2 for deeper solid colours without smudging, Dishwasher proof. whiter than ordinary mug. These features lead to the perfect results of the image transfer.

147-M
11 oz White Sublimation Mug Matte Finish

Best seller mug, best for promotions & personal use.
Dimensions : † 95 mm Ø 80 mm | 325 ml
1 Pack : 36 pcs. | G.W : 13.2 kg

147-D
11 oz White Sublimation Mug Glossy Finish

Best seller mug, best for promotions & personal use.
Dimensions : † 95 mm Ø 80 mm | 325 ml
1 Pack : 36 pcs. | G.W : 13.2 kg



148

15 oz Sublimation Mug

Dimensions : † 115 mm Ø 85 mm | 440 ml
1 Pack : 36 pcs.



169

**10 oz Curved Edge
Sublimation Mug**

Dimensions : † 105 mm Ø 75 mm
1 Pack : 36 pcs. | G.W : 11.6 kg
Capacity : 295 ml



155

**10 oz Straight Edge
Sublimation Mug**

Dimensions : † 105 mm Ø 70 mm
1 Pack : 36 pcs. | G.W : 11.3 kg
Capacity : 295 ml



159-F

**16 oz Frosted
Sublimation Mug**

Dimensions : † 150 mm Ø 80 mm
1 Case : 24 pcs. | G.W : 17.4 kg
Capacity : 470 ml

191
Sublimation Mug with a Heart-shaped Handle.

Dimensions : † 95 mm Ø 85 mm
White mug with glossy finish,
Delivered in set of two mugs.
Perfect gift for couples in love.
1 Pack : 18 pcs.
G.W : 12 kg

158-F
11 oz Frosted Glass Mug

Dimensions : † 98 mm Ø 80 mm
1 Pack : 36 pcs. | G.W : 15.5 kg
Capacity : 325 ml

185
5 oz Saucer Tea Sublimation Mug

Dimensions : † 60 mm Ø 60 mm
1 Pack : 48 pcs. | G.W : 10.5 kg
Capacity : 147 ml

180
4 oz Saucer Tea Sublimation Mug

Dimensions : † 50 mm Ø 80 mm
1 Pack : 36 pcs. | G.W : 13 kg
Capacity : 120 ml

154
6 oz Sublimation Mug

Dimensions : † 50 mm Ø 80 mm
1 Pack : 48 pcs.
G.W : 12 kg
Capacity : 180 ml



149

20 oz Sublimation Beer Mug

Dimensions : † 160 mm Ø 78 mm
1 Pack : 24 pcs. | Capacity : 590 ml

145

22 oz Sublimation Beer Mug

Dimensions : † 170 mm Ø 75 mm
1 Pack : 18 pcs. | Capacity : 650 ml



175-G

11 oz Golden Mug

Dimensions : † 98 mm Ø 80 mm
1 Pack : 36 pcs. | Capacity : 325 ml



175-S

11 oz Silver Mug

Dimensions : † 98 mm Ø 80 mm
1 Pack : 36 pcs. | Capacity : 325 ml



172

11 oz Black Mug with Printable Area.

Dimensions : † 60 mm Ø 60 mm
Mug with white printable area.
The black background makes the colors of the imprinted image even more vibrant.
1 Pack : 36 pcs.
Capacity : 325 ml



182

1.5 oz Short Glass

Dimensions : † 60 mm Ø 45 mm
Conical shape glass with a white printable surface and elegant golden rim.
1 Pack : 144 pcs.
Capacity : 44 ml



170

11 oz Two Tone Mug with Spoon.

Dimensions : † 102 mm Ø 80 mm
 White mug in interesting shape with a colorful parts: interior, handle and spoon. Fully dishwasher proof. Available in 8 different colors.
 1 Pack : 36 pcs. | Capacity : 325 ml

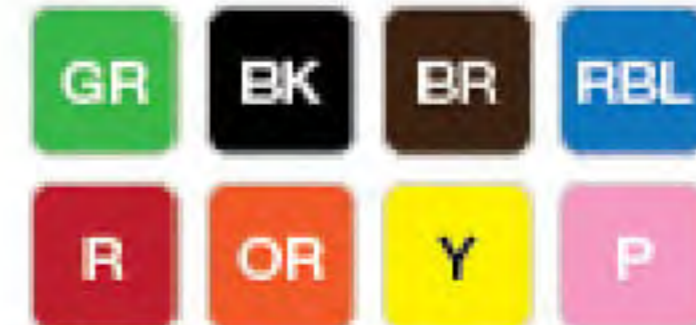

168

11 oz Two Tone Mug

Dimensions : † 98 mm Ø 80 mm
 1 Pack : 36 pcs. | Capacity : 325 ml





190

11 oz Sublimation Mug with Animal handle

Dimensions : † 105 mm Ø 80 mm
 White mug in a animal handle design,
 & coloured trim on top.
 Available in 6 different animals.
 1 Pack : 36 pcs. | Capacity : 325 ml



190-3 (Pig)

190-4 (Mouse)

190-5 (Cow)

190-6 (Cat)

190-7 (Monkey)

190-9 (Giraffe)

Colour Changing Mugs

Just pour hot beverages to reveal your full color designs.

167-BK-M

11 oz Color Changing Mug (Semi-Matte Black Finish)

Dimensions : † 105 mm Ø 80 mm
 1 Pack : 36 pcs. | Capacity : 325 ml



①

Original Color

②

Pour in Hot Beverages
 Changing Stage

③

Design Revealed



139

15 oz Stainless Steel Bottle

Dimensions : † 105 mm Ø 80 mm
1 Box : 60 pcs. | Capacity : 440 ml



144

17 oz White Sublimation Bottle

Dimensions : † 70 mm Ø 265 mm
1 Box : 50 pcs. | Capacity : 500 ml

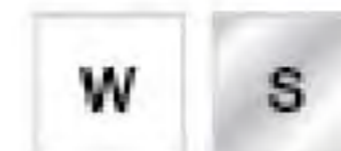

These finely crafted stainless steel travel mugs are excellent for anyone on-the-go.

The rubber-lined pop-top lid keeps liquid inside while the double-walled design keeps liquids hot.



150

14 oz Stainless Steel Mug.

Size : † 145 mm Ø 80 mm
1 Case : 24 pcs.
Capacity : 400 ml



150-W

14 oz Stainless Steel Mug with Printable Area

Size : † 145 mm Ø 80 mm
1 Case : 24 pcs.
Capacity : 400 ml



224

Hardboard Tea Coaster

Dimensions : 10 x 10 cm
 Square shaped with rounded corners.
 Hardboard material
 1 Pack : 120 pcs.



224-S

Wooden Coaster Base

Dimensions : 78 x 65 mm
 Stores a set of 4pcs. Tea coasters.
 1 Pack : 280 pcs.



220-F

Glass Tea Coaster

Dimensions : 10 x 10 cm
 Round shaped glass with
 white printable area for Sublimation
 1 Pack : 120 pcs.



219-F

Glass Tea Coaster

Dimensions : 10 x 10 cm
 Square shaped glass with
 white printable area for Sublimation
 1 Pack : 120 pcs.

223-F
Sublimation Glass Clocks

Dimensions : 30 cm
Our glass clocks are perfect for offices and for custom personalisation. They look fantastic with multi-color photographs and business logos.



Unique, nobly finished boxes for keeping small, personal, precious objects. Made of high quality solid wood. To show the elegance and structure, the wood is varnished in one of three available colors. Upholstered with soft fabric. The lid decorated with printable ceramic tile.



**Available in 4 Different Colors
& in 2 Different Sizes.**

Jewellery Gift Box with Ceramic Tile for Sublimation Printing.

Item Number : 712
Dimensions : 13.5 x 13.5 cm (Small)
Ceramic Tile Size : 10.8 cm
Box Thickness : 7 cm

Item Number : 713
Dimensions : 18 x 18 cm (Large)
Ceramic Tile Size : 15.3 cm
Box Thickness : 7 cm



174
Ceramic Tiles

Size : 20 x 30 cm
1 Pack : 24 pcs.



166
Ceramic Tiles

Size : 20 x 25 cm
1 Pack : 36 pcs.



161
Ceramic Tiles

Size : 20 x 20 cm
1 Pack : 36 pcs.



165
Ceramic Tiles

Size : 5 x 5 cm
1 Pack : 200 pcs.



163
Ceramic Tiles

Size : 10.8 x 10.8 cm
1 Pack : 48 pcs.



162
Ceramic Tiles

Size : 15 x 15 cm
1 Pack : 36 pcs.



164
Ceramic Tiles

Size : 15 x 20 cm
1 Pack : 36 pcs.



162-F
Photo Frame

Size : 19.3 x 19.3 cm
Inside Tile Size :
15 x 15 cm



163-F
Photo Frame

Size : 14.8 x 14.8 cm
Inside Tile Size :
10.8 x 10.8 cm

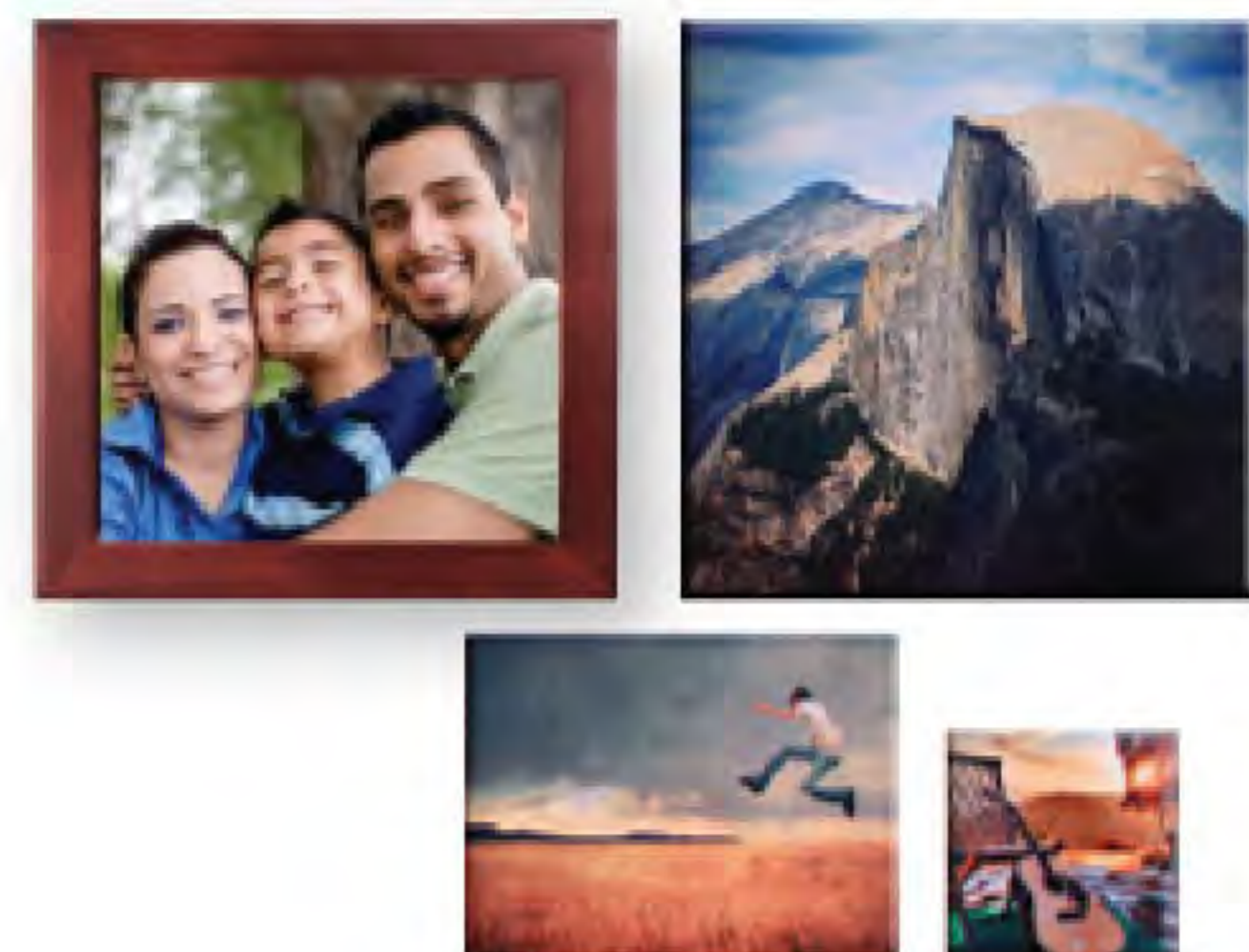

153
10" Ceramic Plate

Size : 254 mm
White ceramic plate with a golden rim design.
1 Pack : 36 pcs.

152
8" Ceramic Plate

Size : 203 mm
White ceramic plate with a golden rim design.
1 Pack : 36 pcs.

250
Bell

Size : 80 x 60 mm
1 Pack : 100 pcs.

246
Star

Size : 75 mm
1 Pack : 100 pcs.

247
Snowflake

Size : 75 mm
1 Pack : 100 pcs.

243
Round

Size : 70 mm
1 Pack : 100 pcs.

249
Dolly Rice

Size : 100 mm
1 Pack : 100 pcs.

248
Dolly Rice

Size : 80 mm
1 Pack : 100 pcs.

242
Heart

Size : 150 mm
1 Pack : 100 pcs.

244
Heart

Size : 100 mm
1 Pack : 100 pcs.

252
Oval

Size : 80 x 60 mm
1 Pack : 100 pcs.

245
Oval Dolly

Size : 90 mm
1 Pack : 100 pcs.

241
Heart

Size : 70 mm
1 Pack : 100 pcs.

251
Christmas

Size : 70 x 85 mm
1 Pack : 100 pcs.

CERAMIC ORNAMENTS

SUBLIMATION PHOTO ROCKS

Have your
precious memories
printed on rocks.



201

Sublimation Rock Photo

Dimensions : 200 x 200 mm
1 Pack : 20 pcs. | G.W. 22 kg



205

Sublimation Rock Photo

Dimensions : 200 x 200 mm
1 Pack : 20 pcs. | G.W. 24 kg



202

Sublimation Rock Photo

Dimensions : 200 x 200 mm
1 Pack : 20 pcs. | G.W. 24 kg



203

Sublimation Rock Photo

Dimensions : 120 x 200 mm
1 Pack : 32 pcs. | G.W. 16 kg



204

Sublimation Rock Photo with wooden frame

Dimensions : 180 x 260 mm
1 Pack : 10 pcs. | G.W. 15 kg

**Sublimation
Photo Crystals**



216-F
Size : 200 x 130 mm
1 Pack : 14 pcs.



210-F
Size : 150 x 165 mm
1 Pack : 14 pcs.



226-F
Size : ? mm
1 Pack : 36 pcs.



218-F
Size : 190 x 100 mm
1 Pack : 14 pcs.



217-F
Size : 190 x 100 mm
1 Pack : 14 pcs.



214-F
Size : 210 x 130 mm
1 Pack : 14 pcs.



209-F
Size : 80 x 60 x 20 mm
1 Pack : 60 pcs.



215-F
Size : 150 x 90 mm
1 Pack : 14 pcs.



206-F
Size : 100 x 150 mm
1 Pack : 14 pcs.



222-F
Size : 180 x 230 mm
1 Pack : 20 pcs.

221-F
Size : 130 x 180 mm
1 Pack : 20 pcs.





Puzzles

A Great way to sharpen the mind while promoting the logo.

The particular parts of the jigsaw are precisely cut and they match each other very well. There is wide choice of models.



PP-02

Sublimation Puzzles

Dimensions : 246 x 170 mm
White printable puzzles made from high quality hardboard.
60 pcs. set

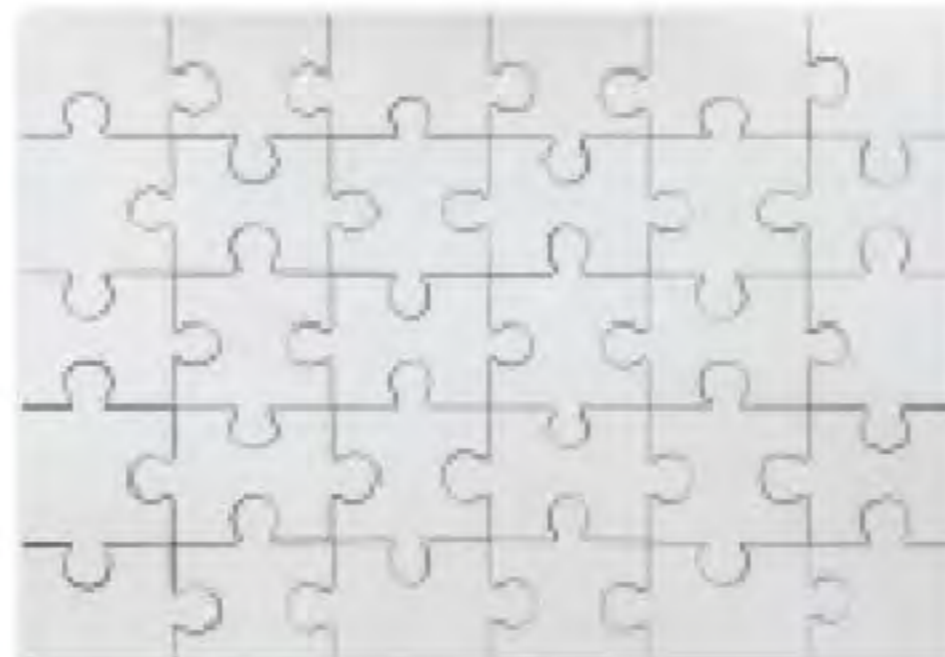

PP-03

Sublimation Puzzles

Dimensions : 246 x 170 mm
White printable puzzles made from high quality hardboard.
30 pcs. set



PP-04

Sublimation Puzzles

Dimensions : 190 x 190 mm
Heart shape puzzles made from cardboard material.



PP-05

Sublimation Puzzles

Dimensions : 200 x 145 mm
White printable puzzles made from cardboard material.
80 pcs. set



PP-06

Sublimation Puzzles

Dimensions : 270 x 180 mm
White printable puzzles made from cardboard material.
126 pcs. set



PP-07

Sublimation Puzzles

Dimensions : 340 x 260 mm
White printable puzzles made from cardboard material.
108 pcs. set



- ▶ Create a unique pillow with your favorite photos printed on the pillow.
- ▶ Best Gifting Product for Wedding, Birthday & Anniversary
- ▶ Eye-catching gift for your loved one.

707

Sublimation Cushions

Dimensions : 35.5 x 40.5 cm
 Printing area : 20 x 20 cm
 Polyester & Cotton material



NW-SUB-6V

Sublimation Bag

Dimensions : 30 x 38 x 12 cm
 White non-woven bag for full color sublimation.



NW-SUB

Sublimation Bag

Dimensions : 37 x 39 cm
 White non-woven bag for full color sublimation.



NW-SUB-A4H

A4 Horizontal Sublimation Bag

Dimensions : 32.5 x 25 x 12 cm
 White non-woven bag for full color sublimation.

NW-SUB-A5

A5 Vertical Sublimation Bag

Dimensions : 19 x 24 x 12 cm
 White non-woven bag for full color sublimation.



193

Promotional Slippers

Unisex, sublimation beach slippers with black, green or orange straps.
Soft wear and Anti-skid
Sole Material : Rubber
Thickness : 15 mm
1 Pack : 20 pairs.



183

Sublimation Tie

Our sublimation white tie is made of polyester, a soft and comfortable material.

Relatively narrow tie that is fashionable & looks good with full color printing.



SC-03

Sublimation Scarf

White Blank Scarf with fringes on both ends.
Material : Polyester



C-A4

A4 Sized Printable Carpet

Carpet Size : 40 x 19.5 cm
Printable Area : 27 x 17.5cm



**Print your photo or design
in Carpet Material by Full Color**



**Customized Carpet
with Frame**

Carpet Size : 20 x 25 cm
Printable Area : 26 x 31 cm





266-A

**Rectangular
Mouse Pad**

Thickness : 5 mm
Product Size : 20 x 23 cm

266-B

**Rectangular
Mouse Pad**

Thickness : 3 mm
Product Size : 20 x 23 cm



263

**Round
Mouse Pad**

Thickness : 3 mm
Product Size : 20 cm



265

**Heart Shaped
Mouse Pad**

Thickness : 3 mm
Product Size : 20 cm



213-F

Crystal Keychains

Glass material with white area
for Sublimation printing.
Thickness : 10 mm
Printable Area : 22 x 32 mm



Coated Aluminum Name Badges

Ideal Badges for Full Color Sublimation Printing
Size : 65 x 18 mm (Minimum of 50pcs. per design)



Reusable Window Insert Name Badges for Sublimation

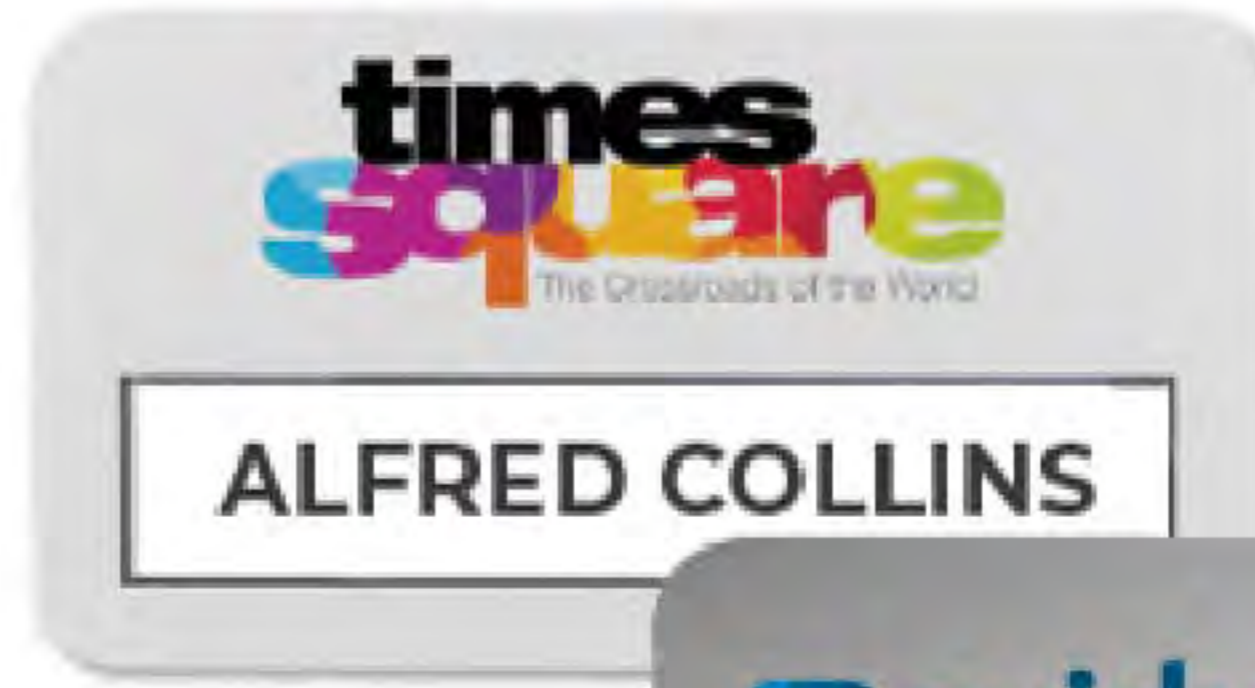

INB-05W

Full Size : 73 x 38 mm
Window Size : 63 x 12 mm



INB-05N

Full Size : 73 x 38 mm
Window Size : 63 x 12 mm



INB-05G

Full Size : 73 x 38 mm
Window Size : 63 x 12 mm

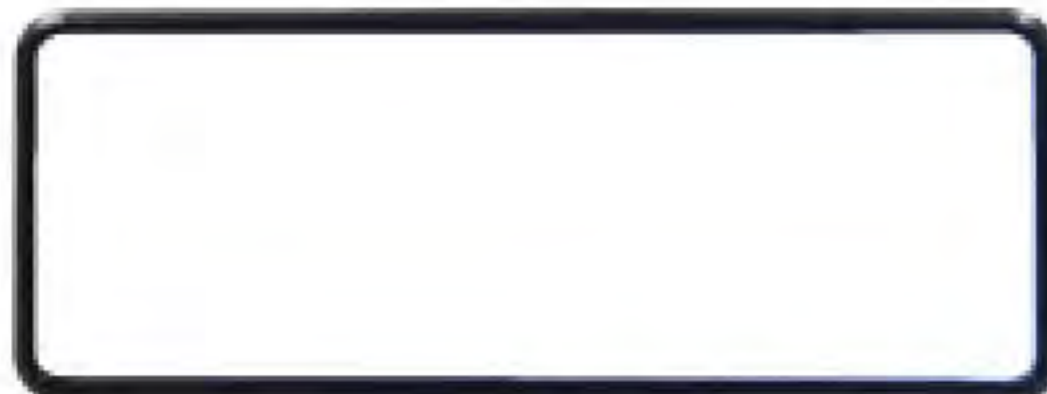

INB-03-W

Reusable White Name Badges

Full Size : 80 x 30 mm
Plate Size : 76 x 26 mm
Backside with magnet

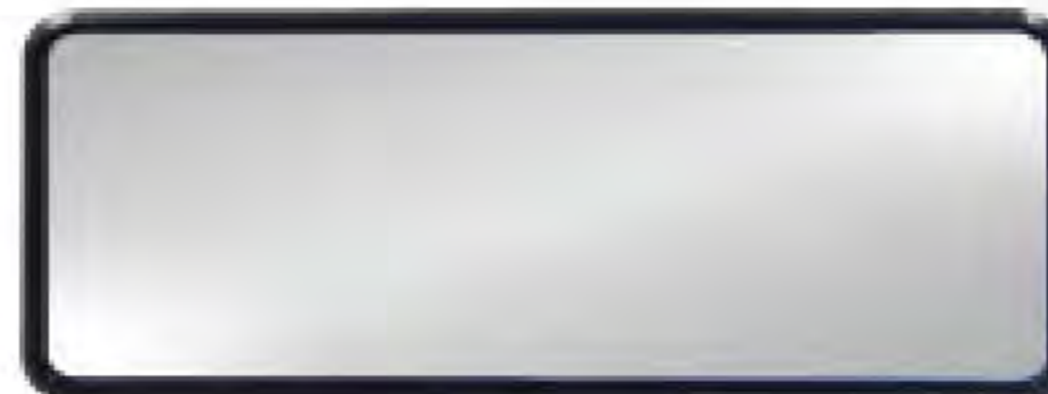

INB-03-W

Reusable Silver Name Badges

Full Size : 80 x 30 mm
Plate Size : 76 x 26 mm
Backside with magnet

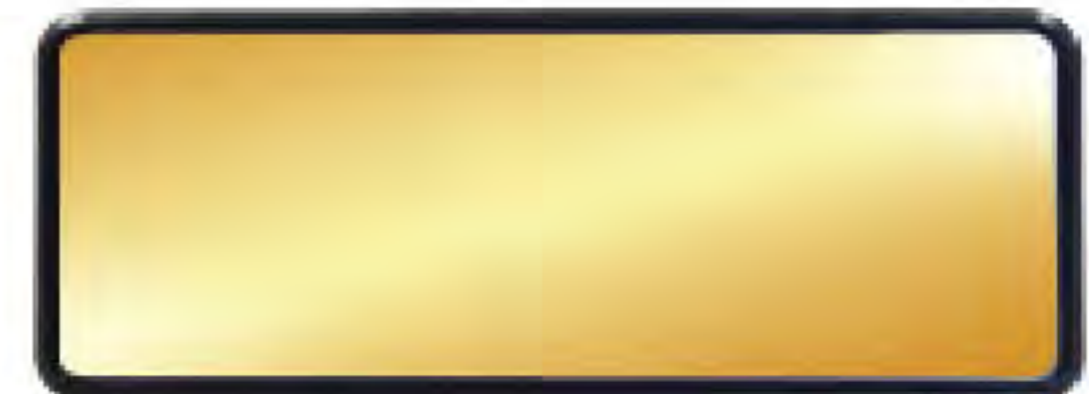

INB-03-W

Reusable Gold Name Badges

Full Size : 80 x 30 mm
Plate Size : 76 x 26 mm
Backside with magnet



Reusable Name Badges for Sublimation

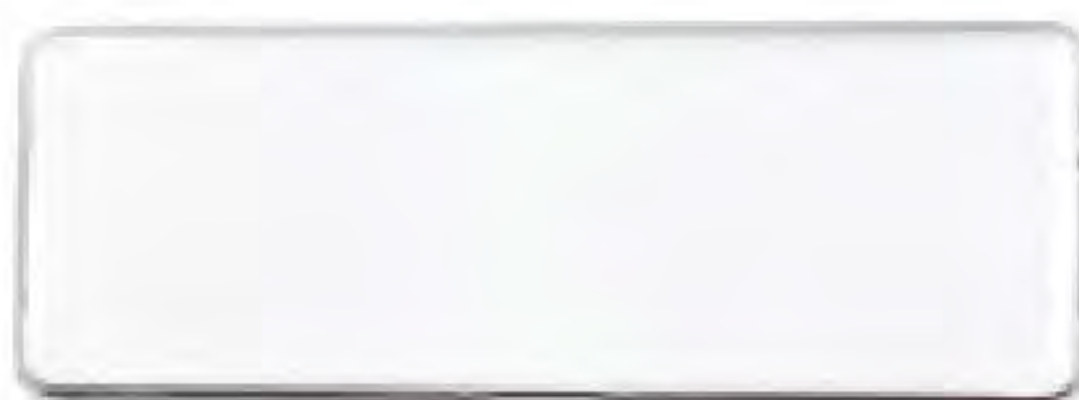

INB-03-W

**Lens Cover Rectangular
White Name Badges**

Size : 80 x 30 mm
Backside with pin or magnet



INB-03-N

**Lens Cover Rectangular
Silver Name Badges**

Size : 80 x 30 mm
Backside with pin or magnet



INB-03-G

**Lens Cover Rectangular
Gold Name Badges**

Size : 80 x 30 mm
Backside with pin or magnet

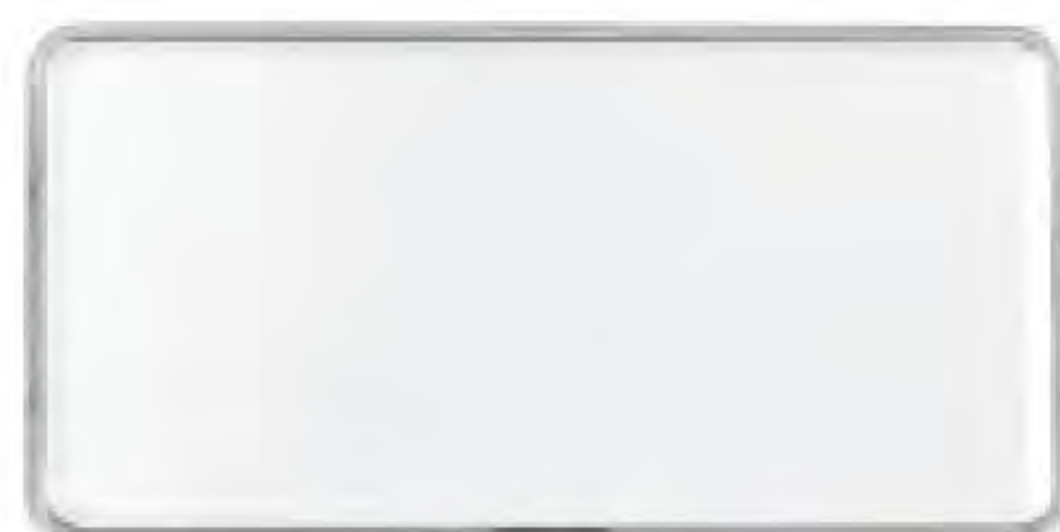

INB-08-W

**Lens Cover Rectangular
White Name Badges**

Size : 80 x 40 mm
Backside with pin or magnet



INB-08-N

**Lens Cover Rectangular
White Name Badges**

Size : 80 x 40 mm
Backside with pin or magnet



INB-08-G

**Lens Cover Rectangular
White Name Badges**

Size : 80 x 40 mm
Backside with pin or magnet



INB-09-W

**Lens Cover Oval
White Name Badges**

Size : 68 x 45 mm
Backside with pin or magnet



INB-09-N

**Lens Cover Oval
Silver Name Badges**

Size : 68 x 45 mm
Backside with pin or magnet



INB-09-G

**Lens Cover Oval
Gold Name Badges**

Size : 68 x 45 mm
Backside with pin or magnet



WSH-01

Silver Wall Sign Holder

WSH-02

Bronze Wall Sign Holder

Metal slide plate for your office, buildings, etc. that is affixed to a wall or other smooth surface for intentional message and informational purposes.
Size : 25.5 x 5.5 cm



WSH-03

Silver Wall Sign Holder

WSH-04

Bronze Wall Sign Holder

A Larger metal slide plate for your office, buildings, etc. that is affixed to a wall or other smooth surface for intentional message and informational purposes.
Size : 25.5 x 10.5 cm



DSH-11

Silver Desk Sign Holder

Metal slide plate for your desk.
Size : 25.5 x 5.5 cm

DSH-12

Bronze Desk Sign Holder

Metal slide plate for your desk.
Size : 25.5 x 5.5 cm

DSH-13

Black Desk Sign Holder

Metal slide plate for your desk.
Size : 25.5 x 5.5 cm



DSH-08

Silver metal desk sign holder with stand (Large)

Dimensions : 120 x 80 mm

DSH-09

Silver metal desk sign holder with stand (Small)

Dimensions : 70 x 60 mm



DSH-05

Transparent Acrylic Desk sign holder (Large)

Dimensions : 148 x 210 mm

DSH-04

Transparent Acrylic Desk sign holder (Small)

Dimensions : 148 x 105 mm



DSH-01

Transparent Acrylic Desk sign holder (Large)

Dimensions : 100 x 65 mm

DSH-02

Transparent Acrylic Desk sign holder (Medium)

Dimensions : 80 x 50 mm

DSH-03

Transparent Acrylic Desk sign holder (Small)

Dimensions : 65 x 45 mm



DSH-06

Transparent Desk Sign Holder with Separate Stand

Dimensions : 75 x 50 mm



DSH-07

Transparent Desk Sign Holder with Separate Stand

Dimensions : 210 x 50 mm



DSH-10

Silver desk sign holder with acrylic

Dimensions : 210 x 100 cm



RAPHAEL LOGO WATCHES

All our watches is carrying a genuine Japan, **PC 21 SEIKO** Movement.
For **Quality , Reliability & Peace of Mind.**

Raphael Watches Branding Options



**Full Color Logo
on Ready Dials**



Laser Marking on Back Case

Back



Customized Photo Dials

ex. Commercial, Educational, Birthdays,
Anniversaries & Wedding or Other types of
Occassions.



WA-01G

43mm - Gents Watch

Printing Options :

- Full Color Logo on Dial
- Metal Marking on Back

WA-01L

32mm - Ladies Watch

Printing Options :

- Full Color Logo on Dial
- Metal Marking on Back

WA-02G

43mm - Gents Watch

Printing Options :

- Full Color Logo on Dial
- Metal Marking on Back

WA-02L

32mm - Ladies Watch

Printing Options :

- Full Color Logo on Dial
- Metal Marking on Back



WA-03G

43mm - Gents Watch

Printing Options :

- Full Color Logo on Dial
- Metal Marking on Back

WA-03L

32mm - Ladies Watch

Printing Options :

- Full Color Logo on Dial
- Metal Marking on Back

WA-05G

44mm - Gents Watch

Printing Options :

- Full Color Logo on Dial
- Metal Marking on Back

WA-05L

30mm - Ladies Watch

Printing Options :

- Full Color Logo on Dial
- Metal Marking on Back



WA-04GG

43mm - Gents Watch

Printing Options :

- Full Color Logo on Dial
- Metal Marking on Back

WA-04LG

28mm - Ladies Watch

Printing Options :

- Full Color Logo on Dial
- Metal Marking on Back

WA-04GS

43mm - Gents Watch

Printing Options :

- Full Color Logo on Dial
- Metal Marking on Back

WA-04LS

28mm - Ladies Watch

Printing Options :

- Full Color Logo on Dial
- Metal Marking on Back



WA-06GS
40mm - Gents Watch
Printing Options:
• Full Color Logo on Dial
• Metal Marking on Back



WA-06GG
40mm - Gents Watch
Printing Options:
• Full Color Logo on Dial
• Metal Marking on Back



WA-07LS-2
35mm - Ladies Watch
Printing Options:
• Full Color Logo on Dial
• Metal Marking on Back



WA-07LS
30mm - Ladies Watch
Printing Options:
• Full Color Logo on Dial
• Metal Marking on Back



WA-07LG-2
35mm - Ladies Watch
Printing Options:
• Full Color Logo on Dial
• Metal Marking on Back



WA-07LG
30mm - Ladies Watch
Printing Options:
• Full Color Logo on Dial
• Metal Marking on Back



WA-08G
41mm - Gents Watch
Printing Options:
• Full Color Logo on Dial
• Metal Marking on Back



WA-09G
43mm - Gents Watch
Printing Options:
• Metal Marking on Back



WA-10GM
46mm - Gents Watch
Printing Options:
• Laser Marking on Dials
• Metal Marking on Back



WA-10GW
46mm - Ladies Watch
Printing Options:
• Full Color Logo on Dial
• Metal Marking on Back



WA-11G
44mm - Gents Watch
Printing Options:
• Metal Marking on Back



WA-15G
43mm - Gents Watch
Printing Options:
• Metal Marking on Back



WA-18G
46mm - Gents Watch
Printing Options :
• Metal Marking on Back



WA-19G
43mm - Gents Watch
Printing Options :
• Metal Marking on Back



WA-23G
42mm - Gents Watch
Printing Options :
• Metal Marking on Back



WA-26G
42mm - Gents Watch
Printing Options :
• Metal Marking on Back



WA-16
46mm - Gents Watch
Printing Options :
• Metal Marking on Back



WA-21G
45mm - Gents Watch
Printing Options :
• Metal Marking on Back



WA-22G
43mm - Gents Watch
Printing Options :
• Metal Marking on Back



WA-24G
44mm - Gents Watch
Printing Options :
• Metal Marking on Back



WA-25G
43mm - Gents Watch
Printing Options :
• Full Color Logo on Dial
• Metal Marking on Back



WA-25L
30mm - Ladies Watch
Printing Options :
• Full Color Logo on Dial
• Metal Marking on Back



WA-12G
44mm - Gents Watch
Printing Options :
• Full Color Logo on Dial
• Metal Marking on Back



WA-13G
43mm - Marble Dial
Printing Options:
• Metal Marking on Back



WA-17
46mm - Elegant Crystals
Printing Options:
• Metal Marking on Back



WA-14G
46mm - Classic Design
Printing Options:
• Full Color Logo on Dial
• Metal Marking on Back

PROMOTIONAL WATCH FOR FULL DIAL PRINTING



WA-10GP
43mm - Gents Watch
Printing Options:
• Full Color Design
• Metal Marking on Back



WA-12GP
44mm - Gents Watch
Printing Options:
• Full Color Design
• Metal Marking on Back



WA-25GP
43mm - Gents Watch
Printing Options:
• Full Color Design
• Metal Marking on Back



WA-25LP
30mm - Ladies Watch
Printing Options:
• Full Color Design
• Metal Marking on Back



WA-20

Full silver watch with keyring attachment.
Size : 43 mm

Printing Options :

- Full Color Design
- Metal Marking on Back

PROMOTIONAL WATCH PACKING BOXES



286

Watch Packing Box

Leather Cover Box with Velvet interior.
Dimensions : 12 x 11.5 x 8.5 cm
Included on every purchase of our
Raphael Promotional Watches.

283

**Rectangular
Watch Packing Box**

Leather Cover Box with Velvet interior.
Dimensions : 20 x 8.5 x 3.5
Optional Box for Watches.



Corporate Luxury Professional



MB-D

A5 Size Notebook with Calendar, Pocket & Pen Holder

A small book with ruled pages for writing notes.
Cover Material : Cloth + Leather
Size : A5 (140 x 210 x 20 mm)



PN52

**Dorniel Metal Pen
with Arabic Traditions Design**

Material : Metal
Size : 140 x 15 mm
Glossy Black Body with Engraving
on Grip, Chrome Clip & Tip.



BK



W



PN50

Dorniel Design Metal Pen

Material : Metal
Barrel : Top-Glossy Black & Top-Glossy White
Grip-Chrome with Texture
Dorniel Logo Engraved on Middle

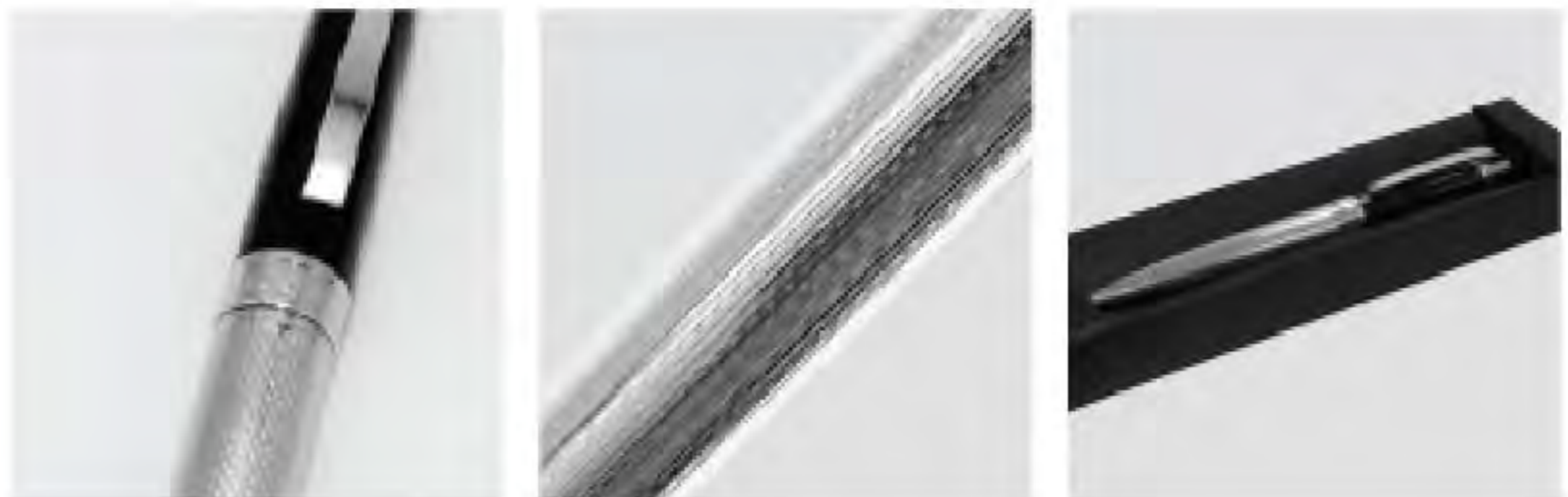

BK



W



PN51

Dorniel Design Metal Pen

Material : Metal
Barrel : Glossy Black & Glossy White
Clip & Tip : Gold Plated
Dorniel Logo Engraved on Middle





 **Powerbank Capacity**
8000 mAh

MB-07-8000

Power bank Portfolio

High quality cloth & PU covered, Power Bank Portfolio comes with phone holder, card holder, pockets elastic webbings for cables & accessories, Pen holder & memo pad.
Product Size : 230 x 300 x 20 mm.



MB-07

**Dorniel Designs
Portfolio Folders**

Smart & Casual : Organize your documents, Gadgets & accessories in one folder.
Available in 2 options.
(1) Full PU leather (2) Grey fabric with PU ID & Card Pockets, Mesh pocket for cables, Mobile Phone Strap & Holder.

MB-07-GY

MB-07-BK



SB-05

**Dorniel Designs
Promotional Backpack**

15.6" Laptop Backpack
Cushion for Laptop protection
Front, Back, Side & Strap Pockets
Padded shoulder strap
Full Black with Leather Backpack
Dimensions : 35 x 45 x 15 cm

SB-06

**Dorniel Designs
Document Bag**

Interior with cushion protection
for your Laptop/Tablets.
Front & Back zipper pocket
Padded shoulder strap
Dimensions : 35 x 26 x 7 cm



SB-03

**Dorniel Designs
Promotional Backpack**

15.6" Laptop Backpack
Cushion for Laptop protection
Tablet Pocket, Padded shoulder strap
Separate space for Folders & Files.
2 Zipper Laptop Backpack
Color : Grey | Interior Color : Black
Dimensions : 30 x 40 x 10 cm



Turn your Ideas to a Product!

CUSTOMIZED PRODUCTS

Large Selection of customized products, such as ; Promotional Silicone USB Flash Drive, Custom-Made Pins & Badges, Customized Ribbon Wristband & Keychain, Customized Silicone Wristband & Keychains, Embroidery Patch, Coins, Paper Shopping Bags, Paper Cups, PVC Plastic Cards & keychains, Custom-Made Scarf Magnet cut-outs, Calendar, Tissue Box, Acrylic Awards, Car Airfreshener, Large Selection of Leather products, Lanyards, Mousepads, Stationery, Roll ups, Frames & more..



Submit
your
Design



Product
Estimate



Confirmation
and
Payment



Production
Starts



Fast
Delivery

CUSTOMIZED SILICONE WRISTBAND

Delivery : 20 - 25 days
 MOQ : 500 pcs.



Silicone Wristband is one of the most popular gift item with its affordable price and unique advertisement. We can promote your logo or message by Embossing / Debossing or Debossing with color filing.

CUSTOMIZED SILICONE KEYCHAIN

Delivery : 20 - 25 days
 MOQ : 500 pcs.



Turn your standard wristbands into wristband keychains!
 With the addition of special hardware, we're able to turn almost any wristband into a keychain.

CUSTOMIZED SILICONE USB FLASH DRIVE

Delivery : 26 - 30 days
MOQ : 500 pcs.



One of the best ways to increase brand recognition is to stand out with a custom silicone USB drive. Virtually any shape imaginable can be recreated on these material which has a high quality flash drives. Tested chip inside the product. Available capacity : 4, 8, 16 or 32 GB.

CUSTOMIZED PINS & BADGES

Delivery : 20 - 25 days
MOQ : 250 pcs.



Create a badge using your own design.
Just send us your design, preferred size and we will make it for you.
It can be chrome, nickel, brass or gold finishing with soft enamel color filing.

CUSTOMIZED RIBBON WRISTBAND

Delivery : 10 - 15 days
 MOQ : 250 pcs.



Event Wristbands in soft polyester, full color sublimation printing on one side.
 Available in 10 mm or 15 mm width, Also available in 2 different clamp / clip options.
 Adjustable plastic clamp or metal clamp.

CUSTOMIZED RIBBON KEYCHAIN

Delivery : 10 - 15 days
 MOQ : 250 pcs.



8 Ribbon Promotional keychain made from Thin, ribbed polyester material.
 These 8 ribbons can be in different colours printed on one side.
 Ribbon size : 15 x 150 mm

CUSTOMIZED EMBROIDERY PATCH

Delivery : 5 - 7 days
MOQ : 100 pcs.



Whether it's sports, academics, business, recognition or for a special event, Promotional coins are a unique reward to celebrate any achievement. Personalize and brand your piece with taglines or logos.

CUSTOMIZED COINS

Delivery : 20 - 25 days
MOQ : 100 pcs.



Whether it's sports, academics, business, recognition or for a special event, Promotional coins are a unique reward to celebrate any achievement. Personalize and brand your piece with taglines or logos.

CUSTOMIZED PAPER SHOPPING BAG

Delivery : 5 - 7 days
MOQ : 500 pcs.



Create a stylish packaging solution for your business, Custom paper bags are a perfect addition to your marketing plan and are an absolute must for any retailers. Personalizing paper bags with your logo can greatly boost your brand exposure.

CUSTOMIZED PAPER CUPS

Delivery : 10 - 14 days
MOQ : 1,000 pcs.



Available in 4 oz, 8 oz and 12 oz



Custom made cups are offered with full color individual print and the high whiteness of the chalked cardboard allows the implementation of imprints in almost photographic quality without any graphic limitations on the entire surface of the paper cup. Single wall paper cup.

CUSTOMIZED PVC PLASTIC CARDS

Delivery : 26 - 30 days
MOQ : 500 pcs.



PVC plastic cards are part of our daily life. Most people are carrying a least one card, whether it's their company ID card, their health club card or a simple photo card. We offer these cards on full color edge-to-edge printing.

CUSTOMIZED PVC KEY RINGS & MAGNET

Delivery : 20 - 25 days
MOQ : 250 pcs.



Our durable PVC material can withstand the messiest adventures without a problem. Create flexible and vibrant designs with unlimited color options. You can create any shape and size that echoes your brand voice.

CUSTOMIZED SCARF

Delivery : 20 - 25 days
MOQ : 250 pcs.



Design your custom scarves to promote your team, event, business or even on personal use. Available in Polyester, Satin or Mesh material.

CUSTOMIZED MAGNETS

Delivery : 5 - 7 days
MOQ : 500 pcs.



- Fridge Magnet
- Calendar Magnet
- Business Card Magnet
- Clip Magnet
- Bookmark Magnet
- Car Magnets



Feature a magnetic back behind high quality color printing of your logo or illustration. Great for different purpose and usage such as the above list;

CUSTOMIZED TABLE CALENDARS

Delivery : 7 - 10 days
MOQ : 250 pcs.



One of the essentials that we refer to every day is a calendar. So when we spend so much time referring to it, for all our important events and plans. Personalized calendars with your logo makes for a great gift to customers to remember you.

CUSTOMIZED TISSUE BOXES

Delivery : 7 - 10 days
MOQ : 500 pcs.



Get Custom Tissue Boxes personalized with your custom logo & design! Makes a great promotional product available on different sizes. 100 ply tissue included.

Custom Made Boxes

Make a great first impressions through custom designed packaging.



Create custom packaging for your Brand with your own desired size, materials & print. Optional materials such as ; Wide Selection of Leather, Velvet, Hardboard & more.

Optional Printing



Debossing



Full Colour UV Printing



Screen Printing

Custom Made Leather Products

Delivery : 5 - 7 days
No MOQ



Create a leather product using your preferred material & color.
then brand it with debossing or full color printing.

Material & Color Options : Below are the available material & colors

 <p>VIVELLA</p> 	 <p>SAVANA</p> 	 <p>MAJESTIC</p> 	 <p>PRESTIGE</p> 	 <p>DUMBO</p> 
 <p>ECLISSE</p> 	 <p>DEDALO</p> 	 <p>FILIGRANA</p> 	 <p>CHARME</p> 	 <p>SIDERAL</p> 
 <p>PARIGINA</p> 	 <p>NEBRASKA</p> 	 <p>GAIA THERMO</p> 	 <p>PONY</p> 	 <p>CORK</p> 
 <p>OSCAR</p> 	 <p>YUYA</p> 	 <p>ACERO</p> 	 <p>MADERA</p> 	 <p>TEJUS</p> 
 <p>PANAMA</p> 	 <p>VIVELLA METAL</p> 	 <p>IGUANA THERMO</p> 	 <p>COROLLA</p> 	

Turn your Ideas into a Product

Sample Customisable Leather Products



Menu Cover with Screw

Dimensions:
A4 (Vertical & Horizontal)



Restaurant Bill Folder

Dimensions:
(S) - 11 x 20 cm
(B) - 16 x 25 cm



Certificate Holder

Dimensions:
A4 (Vertical & Horizontal)



Leather Tea Coaster

Dimensions:
Round - 11 cm
Square - 11 cm



Sample Customisable Leather Products

Office Desk Organizer

A Fully customizable container kept on a desk and used to store stationery and other small items.



Pen / Pencil Holder

Dimensions:
8.5 x 8.5 x 9 cm

Promotional Year Planner

Dimensions:
52 x 45 cm



Leather Card Holder

Dimensions:
8 x 10 cm

Custom Made Lanyards

Steps to create your own lanyard.

- 1 Send your Logo / Design
- 2 Choose your desired clip.
- 3 Choose an add-ons.



Lanyard Details

Lanyard Material : Polyester - Soft In Touch
Dimension : 20mm x 1000mm
Printable Area : Edge to Edge
Printing Option : Sublimation (Full Color Printing)

*Your Design
in Full Colour*



Clip Options



1 Crocodile Clip



2 Oval Hook



3 Carabiner



4 Bottle Opener



5 Trigger Hook

6 Round Shaped Reel Badge

Plastic reel badge with clear strap for ID.
Product Size : 32mm (dia.)
Available in 4 colours.



7 Square Retractable Reel Badge

Customized Lanyard optional part.
For full color printing with epoxy.
Product Size : 28 x 30 mm



Add-ons



Safety Lock



Buckle



Mobile Holder

CUSTOM MADE DOUBLE-HOOK LANYARDS

Soft polyester material for your full colour printing.



Lanyard in Full color edge - to - edge printing.

CUSTOM MADE WOVEN-LOGO LANYARDS

Your Logo is embroidered in up to two colours onto a 1.5 or 2 centimetre flat ribbon lanyard resulting in an incredibly hard-wearing lanyard with a high quality look and feel.



CUSTOM MADE DOUBLE-HOOK LANYARDS

Soft polyester material for your full colour printing.



Lanyard in Full color edge - to - edge printing.

CUSTOM MADE WOVEN-LOGO LANYARDS

Your Logo is embroidered in up to two colours onto a 1.5 or 2 centimetre flat ribbon lanyard resulting in an incredibly hard-wearing lanyard with a high quality look and feel.



Custom Made Acrylic Awards

Delivery : 5 - 7 days
No MOQ



Create a award using the shape of your logo or design.

We can cut it according to your design and print in full color or laser engraving.



We also offer our Pre-made Shapes



1200

Available in 2 sizes
(A) 16 x 14 cm
(B) 20 x 17 cm



1201

Available in 2 sizes
(A) 16 x 14 cm
(B) 20 x 17 cm



1202

Available in 2 sizes
(A) 16 x 14 cm
(B) 20 x 17 cm



1203

Available in 2 sizes
(A) 16 x 14 cm
(B) 20 x 17 cm



1205

Available in 2 sizes
(A) 14 x 16 cm
(B) 17 x 20 cm



1206

Available in 2 sizes
(A) 17 x 13 cm
(B) 22 x 15 cm



1208

Available in 2 sizes
(A) 16 x 13 cm
(B) 21 x 15 cm



1204

Available in 2 sizes
(A) 15 x 13 cm
(B) 20 x 15 cm



1207

Available in 2 sizes
(A) 18 x 13 cm
(B) 22 x 17 cm



1209

Available in 2 sizes
(A) 15 x 15 cm
(B) 20 x 20 cm

Optional Base for Acrylic Awards



1253

Made from wood in black color with gold round area for logo.
Size : 140 x 65 mm



1254

Made from wood in black color with gold round area for logo.
Size : 110 x 65 mm



1255

Made from wood in black color with rectangular area for logo/message.
Size : 50 x 160 mm

CUSTOM MADE COATED ALUMINUM NAME BADGE FOR FULL COLOR SUBLIMATION

Size : 65 x 18 mm (Minimum of 50 pcs. per design)

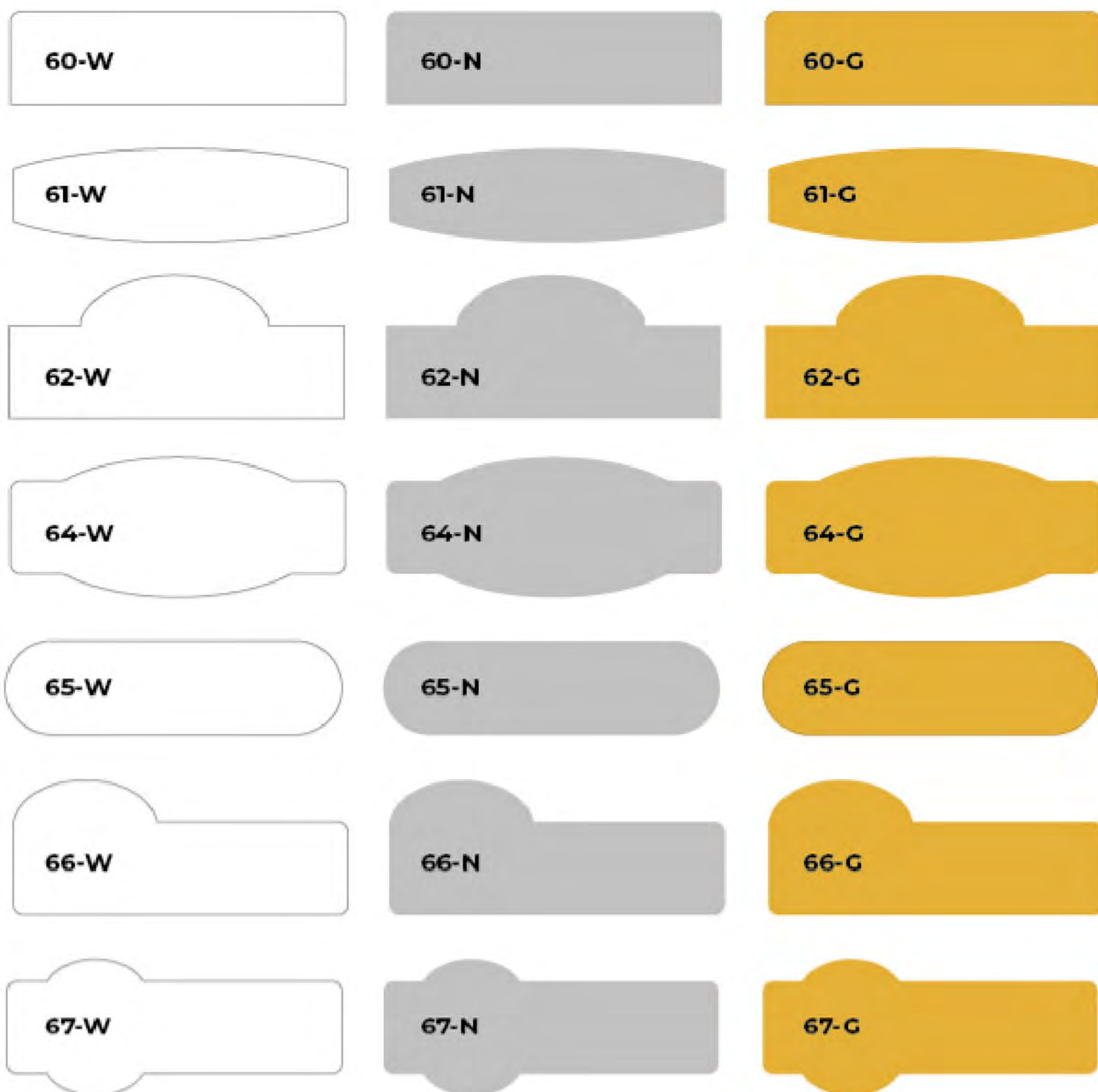

Custom Made Notebooks

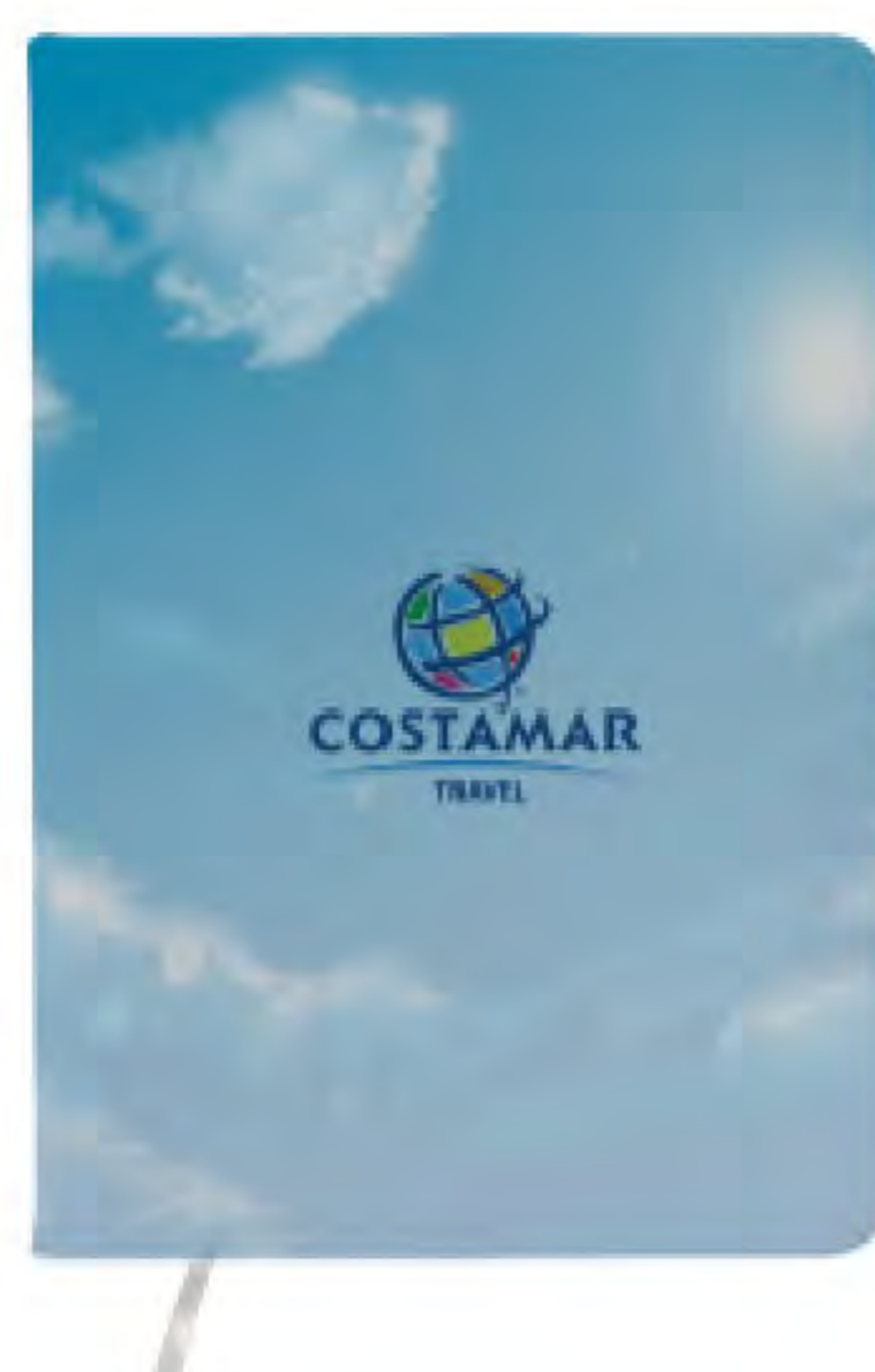
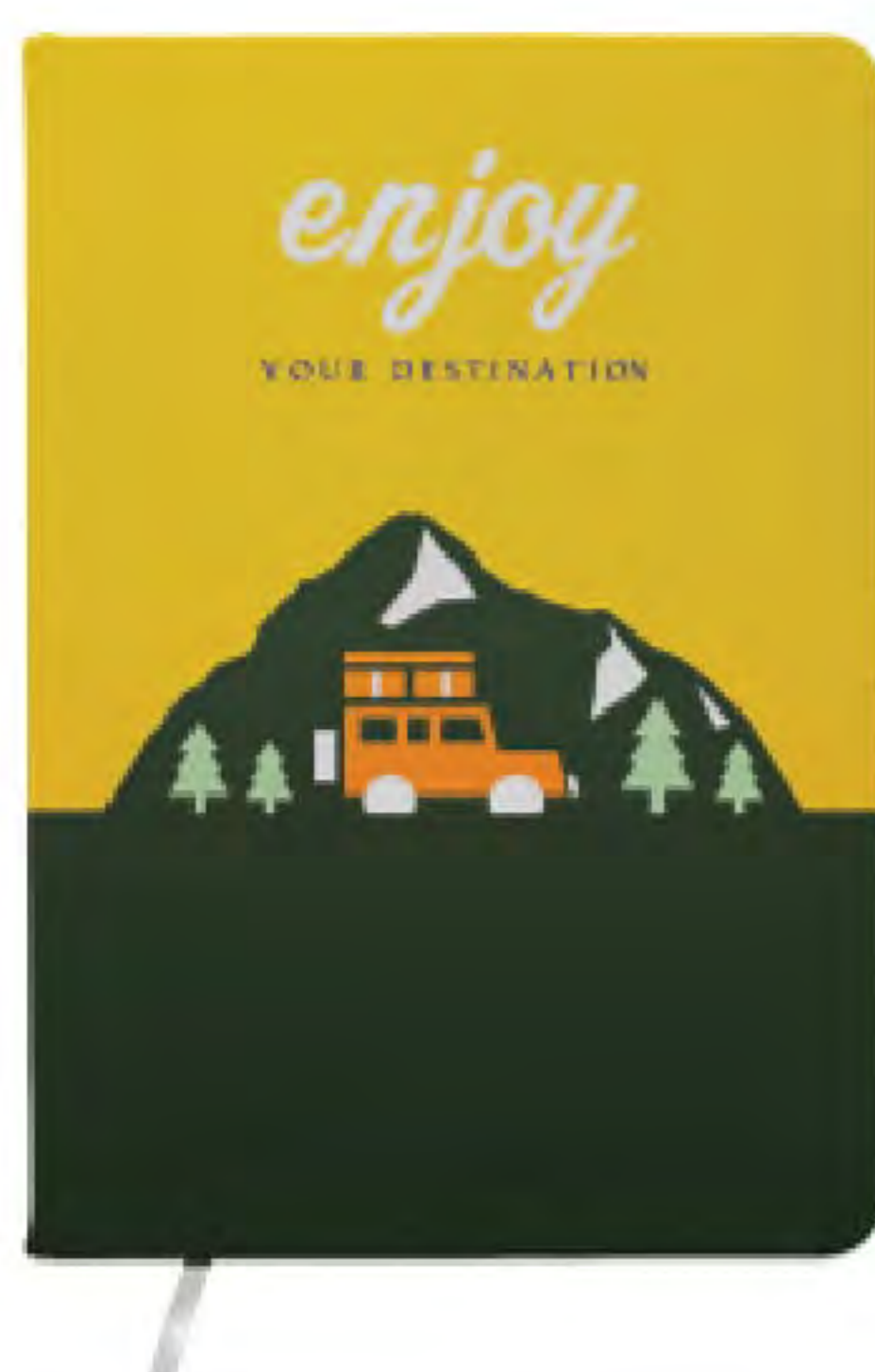

Increase your branding with personalized design notebook covers. Have your Logo with background or advertising printed by offset printing & make it as a cover on your A5 Notebooks.

Turn your Ideas into a Product

STATIONERIES, LETTER HEADS, BUSINESS CARDS.

Delivery : 7 - 10 days
MOQ : 1,000 pcs.



Stationery, Letterheads, Business Cards, Envelopes customized with your brand.

CUSTOMIZED ROLL UPS

Delivery : 3 - 5 days
NO MOQ.



We offer custom printed classic roll up banners. Our banners are perfect lightweight portable advertising tool. Ideal for conferences, promotional events, trade expos and in-store displays, a high-quality pull-up or roll-up banner is a guaranteed route to increasing your brand's visibility.

INSTAGRAM FRAMES

Delivery : 3 - 5 days
NO MOQ.



Great for events / parties and marketing Instagram pages for extra exposure. Customize your details / size & even colors.

Turn your Ideas into a Product

PROMOTIONAL GIFT COLLECTION

**BE A PARTNER
GROW WITH US!**



HIGH PROFILE LLC

Advertising & Management Services

JANNAH LEGASPI

BUSINESS DEVELOPER MANAGER



Al Sheik Muhamad
Bin Sayed Shop #1,
Industrial 11, Sharjah U.A.E.



+971 50 229 6087



info@highprofile-advertising.com



www.highprofile-advertising.com